



## WHEEL 200P2G2B32



<b>Product SKU</b>	200P2G2B32
<b>Standard Compliance</b>	DIN EN 12532
<b>Series</b>	P2G2
<b>Material of the Wheel</b>	polypropylene (PP) wheel center
<b>Tread</b>	thermoplastic rubber tread
<b>Temperature range</b>	-20°C to +60°C
<b>Wheel Diameter</b>	200mm
<b>Load Capacity</b>	250kg
<b>Width of Tread</b>	40mm
<b>wheel hub Width</b>	59mm
<b>Wheel Bolt Size</b>	M12
<b>Bushing Diameter</b>	12mm
<b>Weight</b>	0.75kg
<b>Wheel Bearing</b>	ball bearing
<b>Rubber Shore</b>	70° Shore A



# WHEEL 200P2G2B32

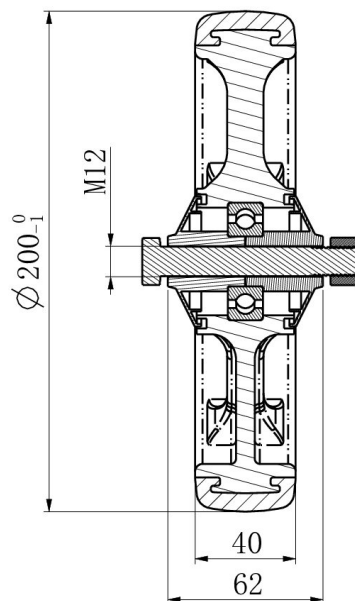
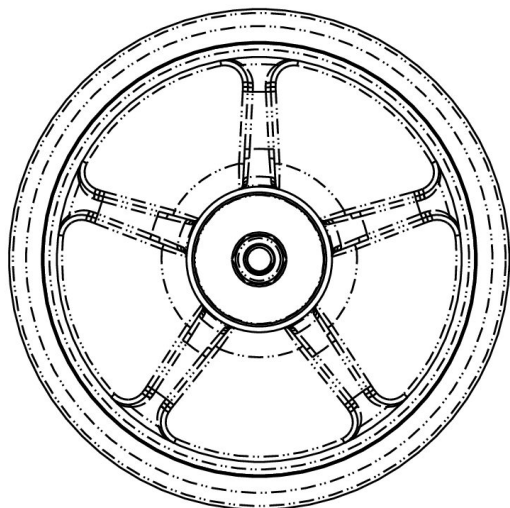

TD_200P2G2B32		
load capacity	250KG	