



WHEEL 160R4F1R0N



Product SKU	160R4F1R0N
Standard Compliance	DIN EN 12532
Series	R4F1
Material of the Wheel	polyamide (PA) wheel center
Tread	elastic tread
Temperature range	-20°C to +80°C
Wheel Diameter	160mm
Load Capacity	300kg
Width of Tread	46mm
wheel hub Width	59mm
Wheel Bolt Size	M12
Bushing Diameter	20mm
Weight	0.88kg
Wheel Bearing	roller bearing
Rubber Shore	75° Shore A



WHEEL 160R4F1R0N

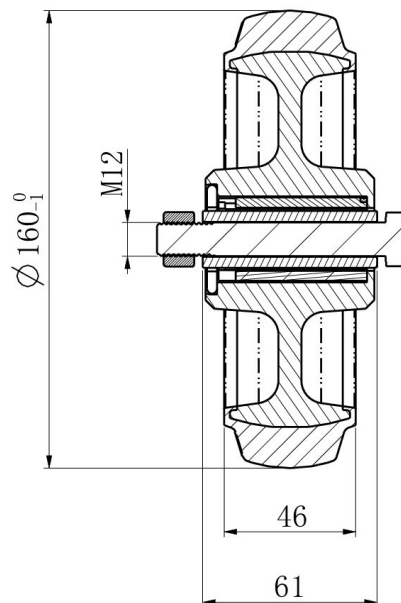
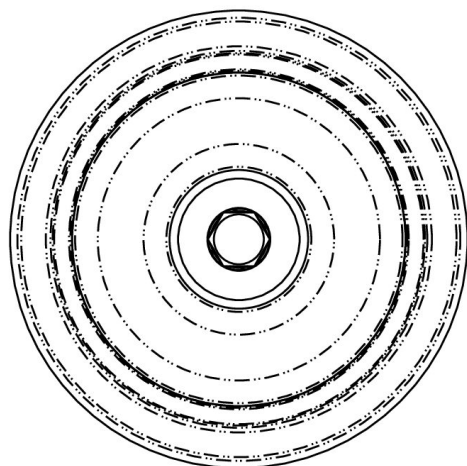

TD_160R4F1R0N		
load capacity	300KG	