



WHEEL 160R4E1D34



Product SKU	160R4E1D34
Standard Compliance	DIN EN 12532
Series	R4E1
Material of the Wheel	polyamide (PA) wheel center
Tread	elastic tread
Temperature range	-20°C to +80°C
Wheel Diameter	160mm
Load Capacity	300kg
Width of Tread	46mm
wheel hub Width	59mm
Wheel Bolt Size	M12
Bushing Diameter	12mm
Weight	0.86kg
Wheel Bearing	double ball bearing
Rubber Shore	65° Shore A



WHEEL 160R4E1D34

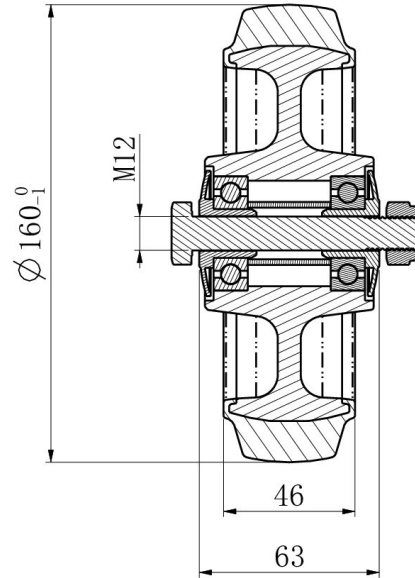
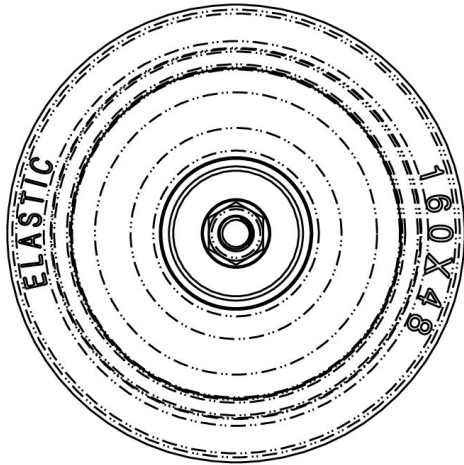

TD_160R4E1D34		
load capacity	300KG	