



WHEEL 160N2U6R1W



Product SKU	160N2U6R1W
Standard Compliance	DIN EN 12532
Series	N2U6
Material of the Wheel	polyamide (PA) wheel center
Tread	polyurethane (PU) tread
Temperature range	-40°C to +80°C
Wheel Diameter	160mm
Load Capacity	350kg
Width of Tread	40mm
wheel hub Width	59mm
Wheel Bolt Size	M12
Bushing Diameter	20mm
Weight	0.77kg
Wheel Bearing	roller bearing
Rubber Shore	95° Shore A



WHEEL 160N2U6R1W

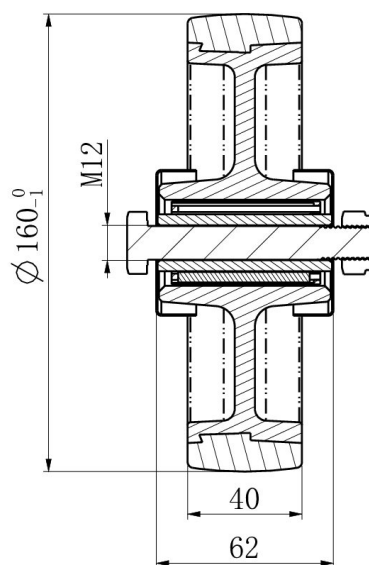
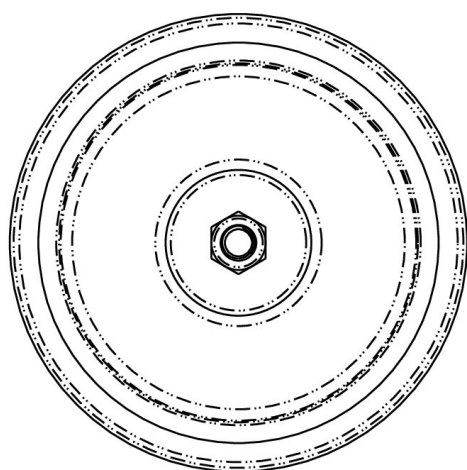

TD_160N2U6R1W	
load capacity	300KG

