

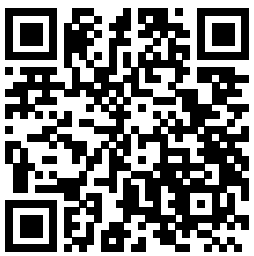

WHEEL 125R4F1R0N



Product SKU	125R4F1R0N
Standard Compliance	DIN EN 12532
Series	R4F1
Material of the Wheel	polyamide (PA) wheel center
Tread	elastic tread
Temperature range	-20°C to +80°C
Wheel Diameter	125mm
Load Capacity	200kg
Width of Tread	38mm
wheel hub Width	50mm
Wheel Bolt Size	M10
Bushing Diameter	15mm
Weight	0.45kg
Wheel Bearing	roller bearing
Rubber Shore	75° Shore A





WHEEL 125R4F1R0N

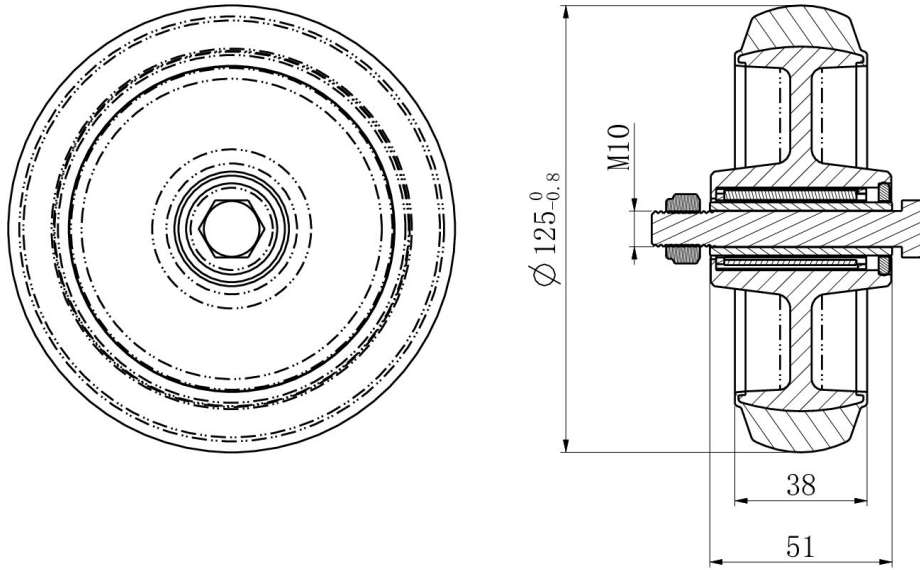

TD_125R4F1R0N		
load capacity	200KG	