



WHEEL 100R4F1R0N



Product SKU	100R4F1R0N
Standard Compliance	DIN EN 12532
Series	R4F1
Material of the Wheel	polyamide (PA) wheel center
Tread	elastic tread
Temperature range	-20°C to +80°C
Wheel Diameter	100mm
Load Capacity	160kg
Width of Tread	35mm
wheel hub Width	40mm
Wheel Bolt Size	M8
Bushing Diameter	12mm
Weight	0.27kg
Wheel Bearing	roller bearing
Rubber Shore	75° Shore A



WHEEL 100R4F1R0N

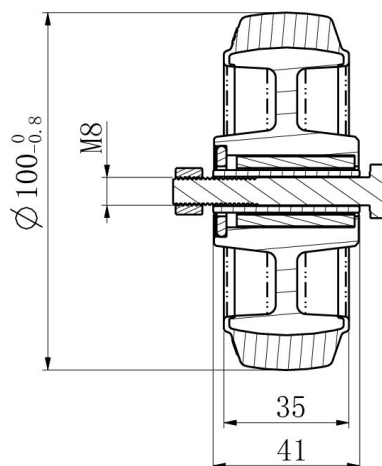
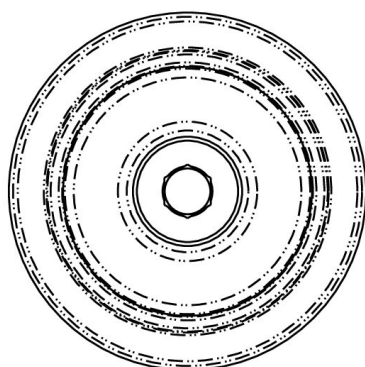

TD_100R4F1R0N		
load capacity	160KG	