



WHEEL 100P2G2B32A



Product SKU	100P2G2B32A
Standard Compliance	DIN EN 12532
Series	P2G2 (antistatic)
Material of the Wheel	polypropylene (PP) wheel center
Tread	thermoplastic rubber tread
Temperature range	-20°C to +60°C
Wheel Diameter	100mm
Load Capacity	90kg
Width of Tread	32mm
wheel hub Width	40mm
Wheel Bolt Size	M8
Bushing Diameter	8mm
Wheel Bearing	ball bearing
Special Features	antistatic





WHEEL 100P2G2B32A

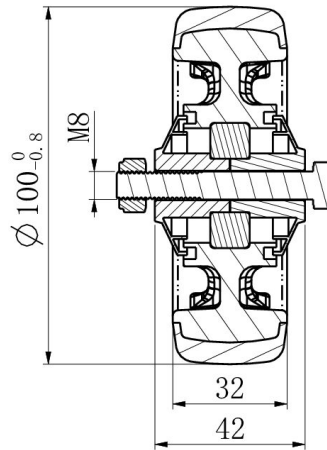
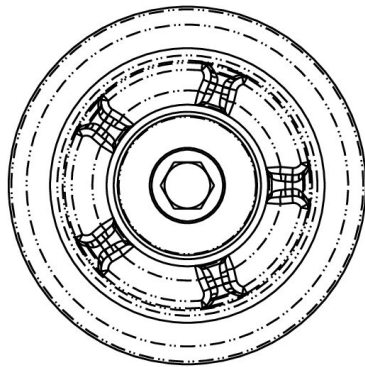

TD_100P2G2B32A	
load capacity	90KG

