



## WHEEL 100P2G2B32



<b>Product SKU</b>	100P2G2B32
<b>Standard Compliance</b>	DIN EN 12532
<b>Series</b>	P2G2
<b>Material of the Wheel</b>	polypropylene (PP) wheel center
<b>Tread</b>	thermoplastic rubber tread
<b>Temperature range</b>	-20°C to +60°C
<b>Wheel Diameter</b>	100mm
<b>Load Capacity</b>	135kg
<b>Width of Tread</b>	32mm
<b>wheel hub Width</b>	40mm
<b>Wheel Bolt Size</b>	M8
<b>Bushing Diameter</b>	8mm
<b>Weight</b>	0.22kg
<b>Wheel Bearing</b>	ball bearing
<b>Rubber Shore</b>	70° Shore A



# WHEEL 100P2G2B32

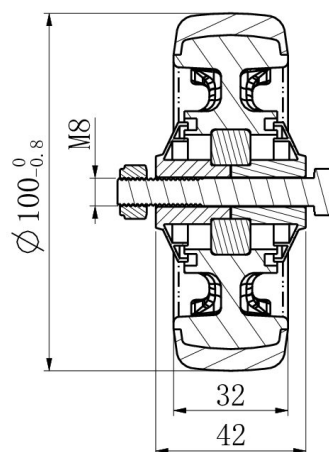
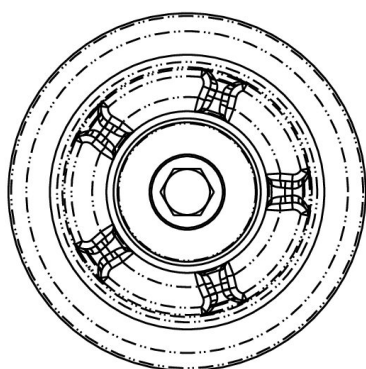

TD_100P2G2B32		
load capacity	135KG	