



WHEEL 100N0N0P0N



Product SKU	100N0N0P0N
Standard Compliance	DIN EN 12532
Series	N0N0
Material of the Wheel	polyamide (PA) wheel center
Tread	polyamide (PA) tread
Temperature range	-40°C to +80°C
Wheel Diameter	100mm
Load Capacity	150kg
Width of Tread	36mm
wheel hub Width	40mm
Wheel Bolt Size	M8
Bushing Diameter	12mm
Weight	0.16kg
Wheel Bearing	plain bearing



WHEEL 100N0N0P0N

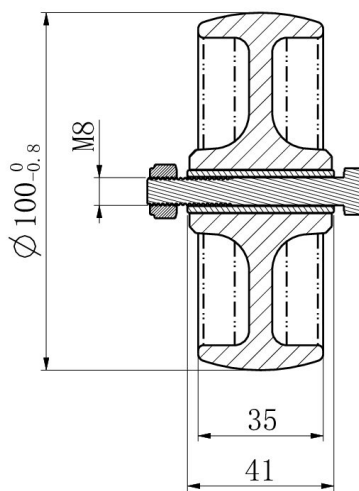
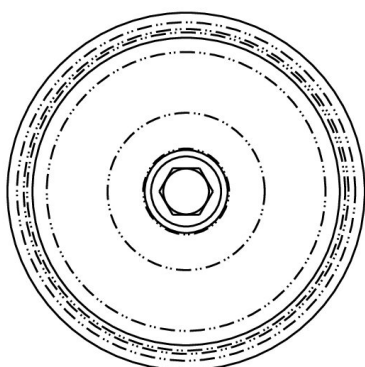

TD_100N0N0P0N		
load capacity	150KG	