



WHEEL 100M6N2B32



Product SKU	100M6N2B32
Standard Compliance	DIN EN 12532
Series	M6N2
Material of the Wheel	polyamide (PA) wheel center
Tread	polyamide (PA) tread
Temperature range	-20°C to +80°C
Wheel Diameter	100mm
Load Capacity	160kg
Width of Tread	36mm
wheel hub Width	40mm
Wheel Bolt Size	M8
Bushing Diameter	8mm
Wheel Bearing	ball bearing



WHEEL 100M6N2B32

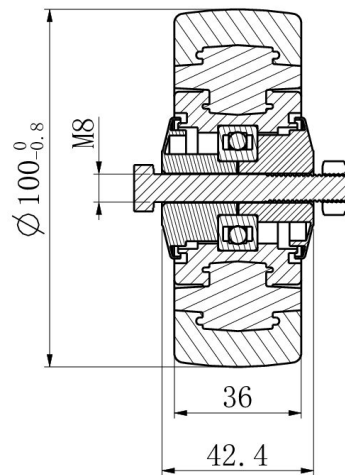
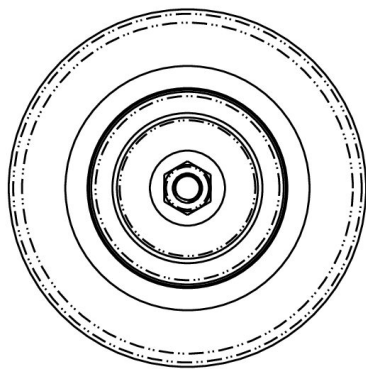

TD_100M6N2B32		
load capacity	160KG	