



## WHEEL 082SWU5D0N-70



<b>Product SKU</b>	082SWU5D0N-70
<b>Material of the Wheel</b>	steel wheel center
<b>Tread</b>	cast polyurethane (CPU) tread
<b>Temperature range</b>	-20°C to +60°C
<b>Wheel Diameter</b>	82mm
<b>Load Capacity</b>	510kg
<b>Wheel Bearing</b>	double ball bearing
<b>Rubber Shore</b>	95° Shore A



# WHEEL 082SWU5D0N-70

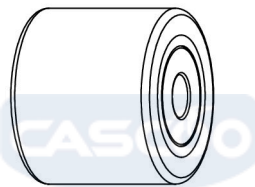
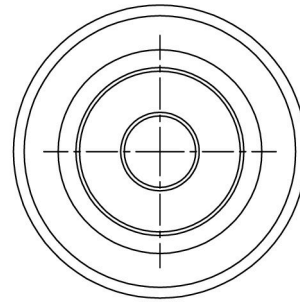
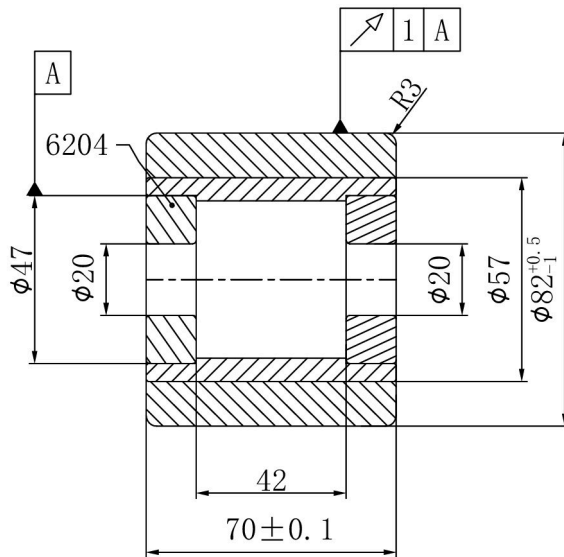

082SWU5D0N-70		
load capacity	510KG	