



WHEEL 082SWU5D0N-60



Product SKU	082SWU5D0N-60
Material of the Wheel	steel wheel center
Tread	cast polyurethane (CPU) tread
Temperature range	-20°C to +60°C
Wheel Diameter	82mm
Load Capacity	440kg
Wheel Bearing	double ball bearing
Rubber Shore	95° Shore A



WHEEL 082SWU5D0N-60

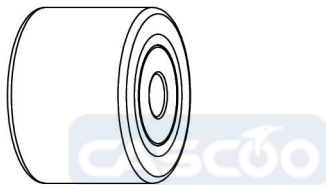
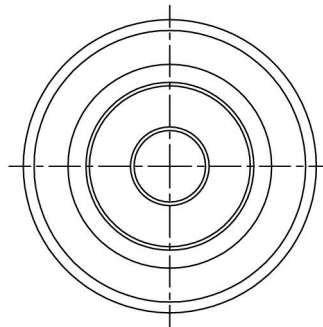
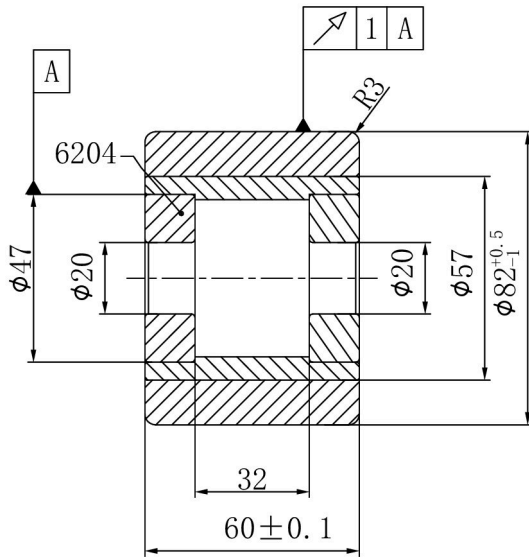

082SWU5D0N-60		
load capacity	440KG	