



WHEEL 080R4E1B34



Product SKU	080R4E1B34
Standard Compliance	DIN EN 12532
Series	R4E1
Material of the Wheel	polyamide (PA) wheel center
Tread	elastic tread
Temperature range	-20°C to +80°C
Wheel Diameter	80mm
Load Capacity	150kg
Width of Tread	35mm
wheel hub Width	40mm
Wheel Bolt Size	M8
Bushing Diameter	8mm
Weight	0.16kg
Wheel Bearing	ball bearing
Rubber Shore	65° Shore A





WHEEL 080R4E1B34

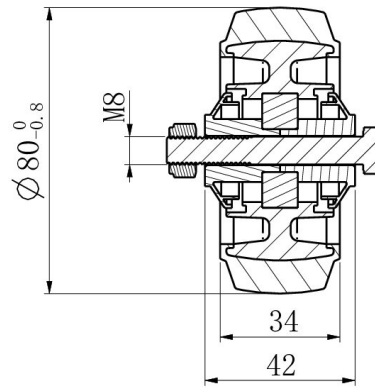

TD_080R4E1B34		
load capacity	150KG	