

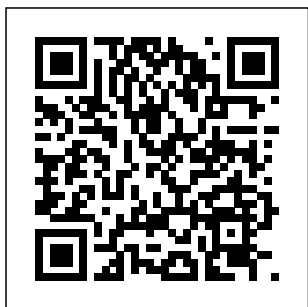

## WHEEL 080P4S4R0N



<b>Product SKU</b>	080P4S4R0N
<b>Standard Compliance</b>	DIN EN 12532
<b>Series</b>	P4S4
<b>Material of the Wheel</b>	polypropylene (PP) wheel center
<b>Tread</b>	solid rubber tread
<b>Temperature range</b>	-20°C to +60°C
<b>Wheel Diameter</b>	80mm
<b>Load Capacity</b>	70kg
<b>Width of Tread</b>	32mm
<b>wheel hub Width</b>	40mm
<b>Wheel Bolt Size</b>	M8
<b>Bushing Diameter</b>	12mm
<b>Weight</b>	0.19kg
<b>Wheel Bearing</b>	roller bearing
<b>Rubber Shore</b>	85° Shore A



# WHEEL 080P4S4R0N

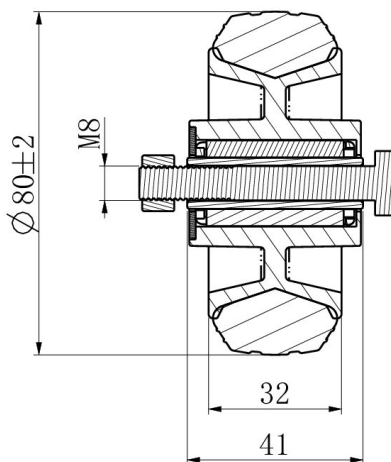

TD_080P4S4R0N		
load capacity	70KG	