



WHEEL 080N2U6B32



Product SKU	080N2U6B32
Standard Compliance	DIN EN 12532
Series	N2U6
Material of the Wheel	polyamide (PA) wheel center
Tread	polyurethane (PU) tread
Temperature range	-40°C to +80°C
Wheel Diameter	80mm
Load Capacity	130kg
Width of Tread	32mm
wheel hub Width	40mm
Wheel Bolt Size	M8
Bushing Diameter	8mm
Weight	0.2kg
Wheel Bearing	ball bearing
Rubber Shore	95° Shore A



WHEEL 080N2U6B32

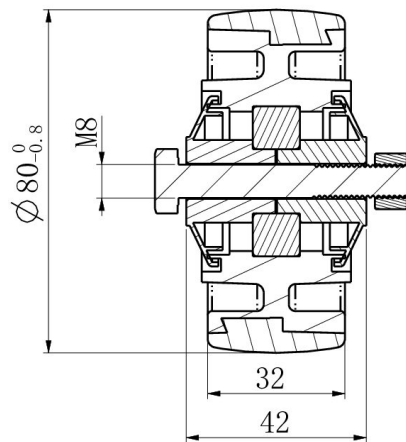
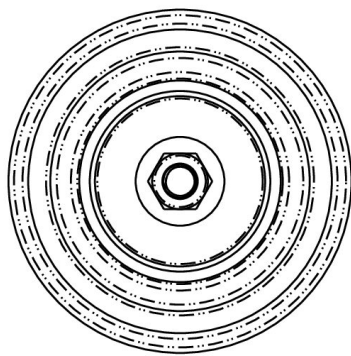

TD_080N2U6B32

load
capacity

130KG

