



WHEEL 080N0N0P0N



Product SKU	080N0N0P0N
Standard Compliance	DIN EN 12532
Series	N0N0
Material of the Wheel	polyamide (PA) wheel center
Tread	polyamide (PA) tread
Temperature range	-40°C to +80°C
Wheel Diameter	80mm
Load Capacity	130kg
Width of Tread	34mm
wheel hub Width	40mm
Wheel Bolt Size	M8
Bushing Diameter	12mm
Weight	0.13kg
Wheel Bearing	plain bearing





WHEEL 080N0N0P0N

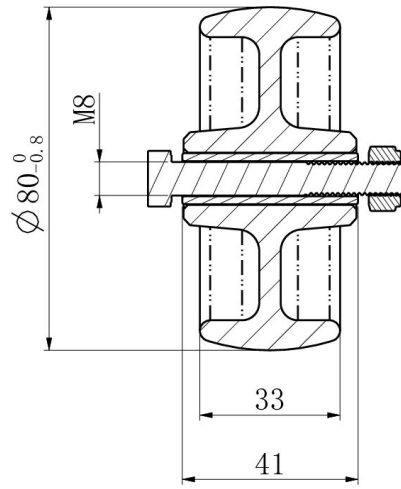
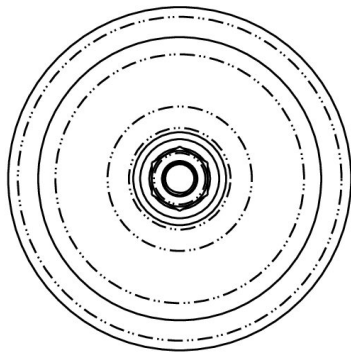

TD_080N0N0P0N		
load capacity	130KG	