

CASTOR TPP58WC200R4F1R0N



Product SKU	TPP58WC200R4F1R0N
Standard Compliance	DIN EN 12532
Series	R4F1
Fastening	Plate fastening
Brake and Direction	back brake
Material of the Wheel	polyamide (PA) wheel center
Tread	elastic tread
Temperature range	-20°C to +80°C
Wheel Diameter	200mm
Load Capacity	350kg
Total Height	235mm
Width of Tread	46mm
wheel hub Width	59mm
Offset	55mm
Dimension of Plate	135x110mm
Hole Spacing of the Plate	105x84/76mm
Swivel Radius	165mm
Wheel Bolt Size	M12
Bushing Diameter	20mm
Weight	2.76kg
Wheel Bearing	roller bearing
Rubber Shore	75° Shore A



CASTOR TPP58WC200R4F1R0N

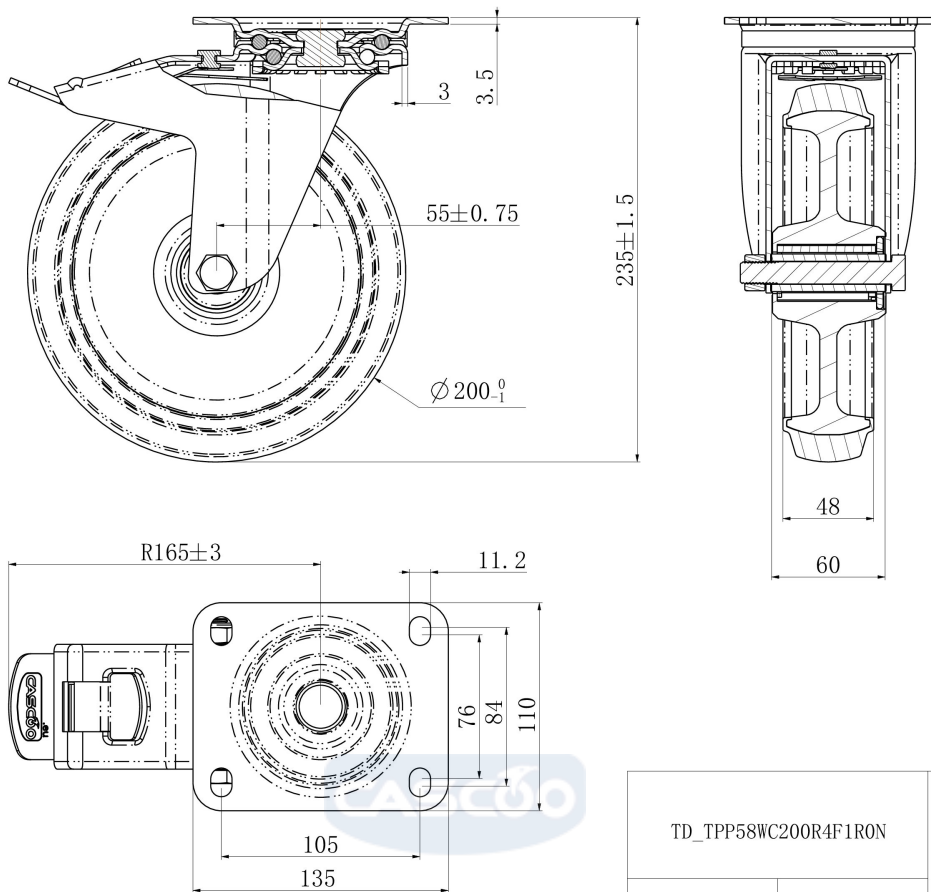

TD_TPP58WC200R4F1R0N		
load capacity	350KG	