

CASTOR TPP21WC100R4E1B34



Product SKU	TPP21WC100R4E1B34
Standard Compliance	DIN EN 12532
Series	R4E1
Fastening	Plate fastening
Brake and Direction	back brake
Material of the Wheel	polyamide (PA) wheel center
Tread	elastic tread
Temperature range	-20°C to +80°C
Wheel Diameter	100mm
Load Capacity	200kg
Total Height	128mm
Width of Tread	35mm
wheel hub Width	40mm
Offset	40mm
Dimension of Plate	105x80mm
Hole Spacing of the Plate	80/77x60mm
Swivel Radius	127mm
Wheel Bolt Size	M8
Bushing Diameter	8mm
Weight	0.92kg
Wheel Bearing	ball bearing
Rubber Shore	65° Shore A



CASTOR TPP21WC100R4E1B34

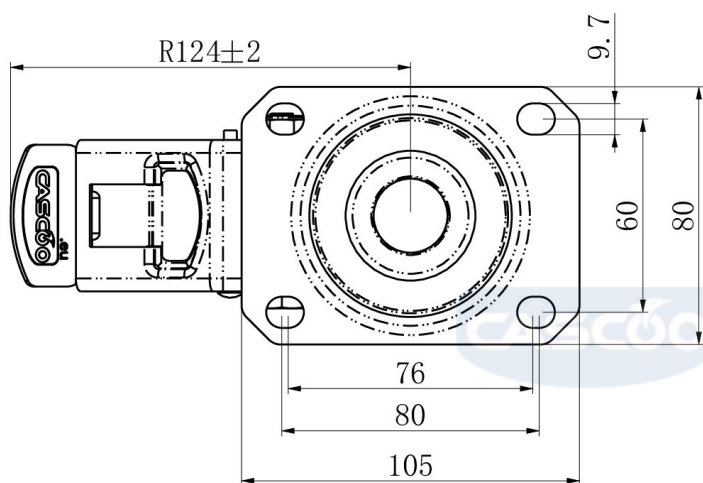
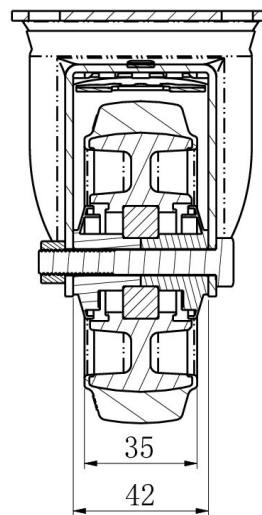
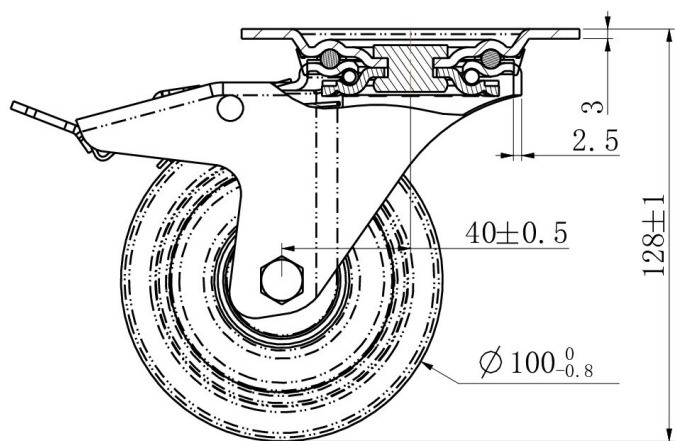

TD_TPP21WC100R4E1B34		
load capacity	200KG	