

CASTOR TBP35WC125P2G2B32



Product SKU	TBP35WC125P2G2B32
Standard Compliance	DIN EN 12532
Series	P2G2
Fastening	Plate fastening
Brake and Direction	back brake
Material of the Wheel	polypropylene (PP) wheel center
Tread	thermoplastic rubber tread
Temperature range	-20°C to +60°C
Wheel Diameter	125mm
Load Capacity	165kg
Total Height	155mm
Width of Tread	35mm
wheel hub Width	50mm
Offset	45mm
Dimension of Plate	105x80mm
Hole Spacing of the Plate	80/77x60mm
Swivel Radius	127mm
Wheel Bolt Size	M10
Bushing Diameter	10mm
Weight	0.96kg
Wheel Bearing	ball bearing
Rubber Shore	70° Shore A



CASTOR TBP35WC125P2G2B32

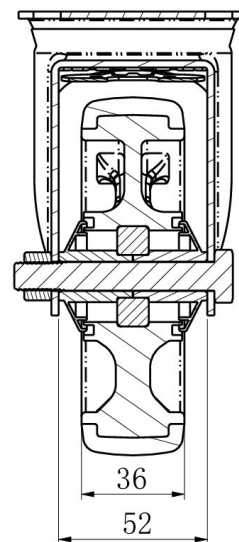
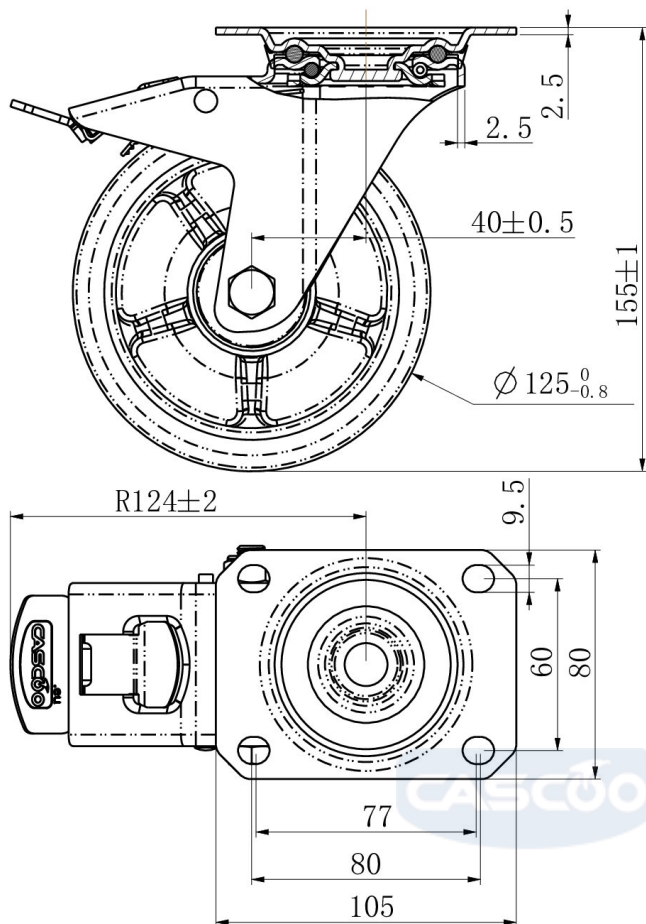

TD_TBP35WC125P2G2B32

load
capacity

165KG

