

CASTOR TBP35WC125N2U6R1W

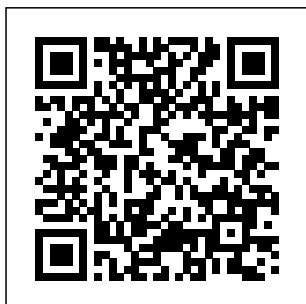

Product SKU	TBP35WC125N2U6R1W
Standard Compliance	DIN EN 12532
Series	N2U6
Fastening	Plate fastening
Brake and Direction	back brake
Material of the Wheel	polyamide (PA) wheel center
Tread	polyurethane (PU) tread
Temperature range	-40°C to +80°C
Wheel Diameter	125mm
Load Capacity	200kg
Total Height	155mm
Width of Tread	32mm
wheel hub Width	50mm
Offset	45mm
Dimension of Plate	105x80mm
Hole Spacing of the Plate	80/77x60mm
Swivel Radius	127mm
Wheel Bolt Size	M10
Bushing Diameter	15mm
Weight	1.05kg
Wheel Bearing	roller bearing
Rubber Shore	95° Shore A



CASTOR TBP35WC125N2U6R1W

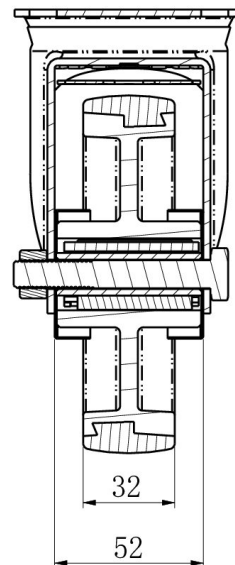
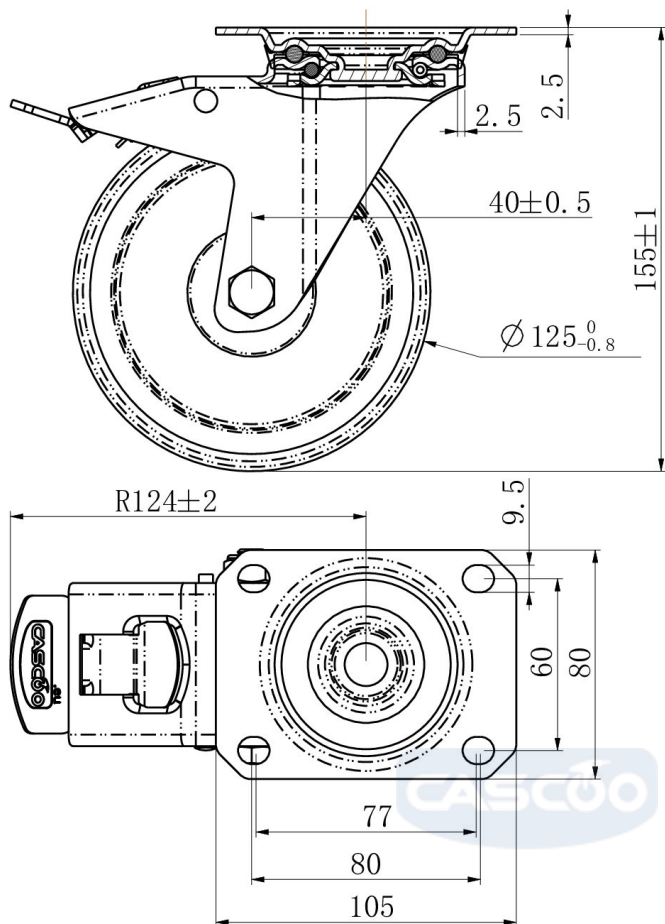

TD_TBP35WC125N2U6R1W		
load capacity	200KG	