

CASTOR SPP58WC160P2G2B32A



Product SKU	SPP58WC160P2G2B32A
Standard Compliance	DIN EN 12532
Series	P2G2 (antistatic)
Fastening	Plate fastening
Brake and Direction	swivel without brake
Material of the Wheel	polypropylene (PP) wheel center
Tread	thermoplastic rubber tread
Temperature range	-20°C to +60°C
Wheel Diameter	160mm
Load Capacity	135kg
Total Height	195mm
Width of Tread	40mm
wheel hub Width	59mm
Offset	55mm
Dimension of Plate	135x110mm
Hole Spacing of the Plate	105x84/76mm
Wheel Bolt Size	M12
Bushing Diameter	12mm
Weight	1.68kg
Wheel Bearing	ball bearing
Special Features	antistatic



CASTOR SPP58WC160P2G2B32A

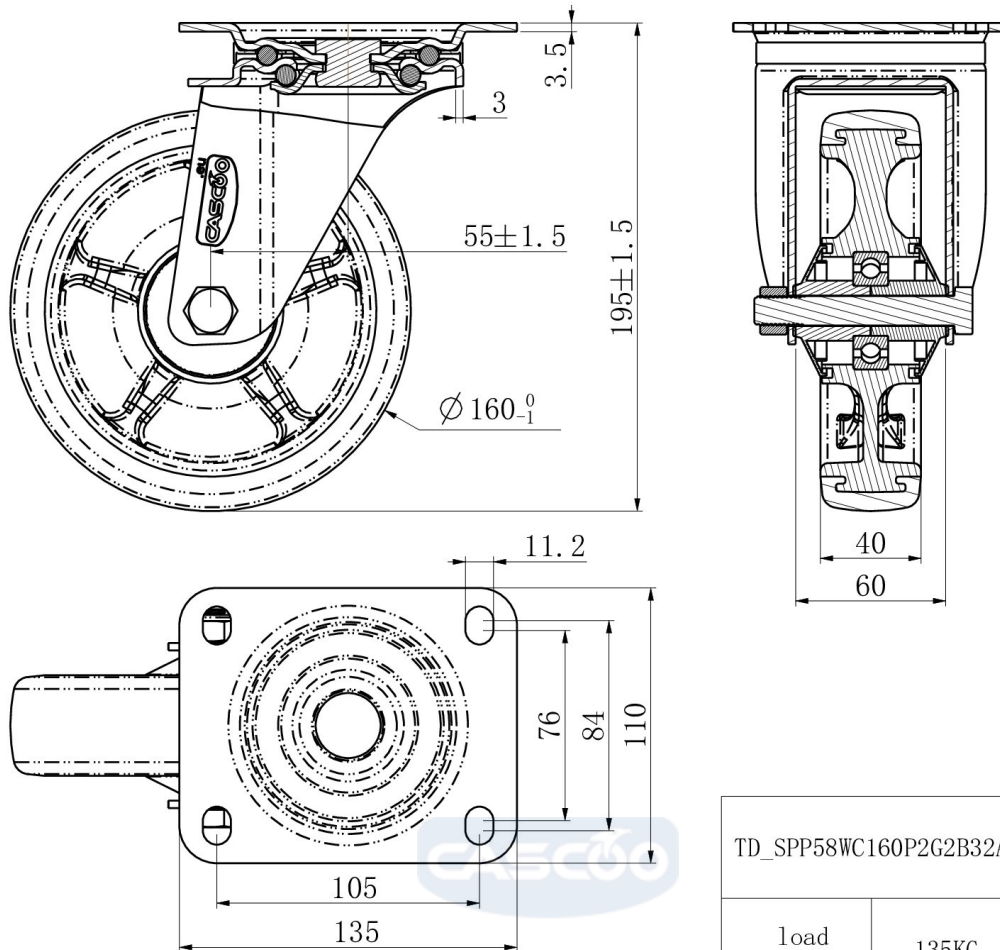

TD_SPP58WC160P2G2B32A

load capacity

135KG

