

CASTOR SPP21WC100P2D2B32



Product SKU	SPP21WC100P2D2B32
Standard Compliance	DIN EN 12532
Series	P2D2
Fastening	Plate fastening
Brake and Direction	swivel without brake
Material of the Wheel	polypropylene (PP) wheel center
Tread	thermoplastic rubber tread
Temperature range	-20°C to +60°C
Wheel Diameter	100mm
Load Capacity	135kg
Total Height	128mm
Width of Tread	35mm
wheel hub Width	40mm
Offset	40mm
Dimension of Plate	105x80mm
Hole Spacing of the Plate	80/77x60mm
Wheel Bolt Size	M8
Bushing Diameter	8mm
Weight	0.68kg
Wheel Bearing	ball bearing
Rubber Shore	70° Shore A



CASTOR SPP21WC100P2D2B32

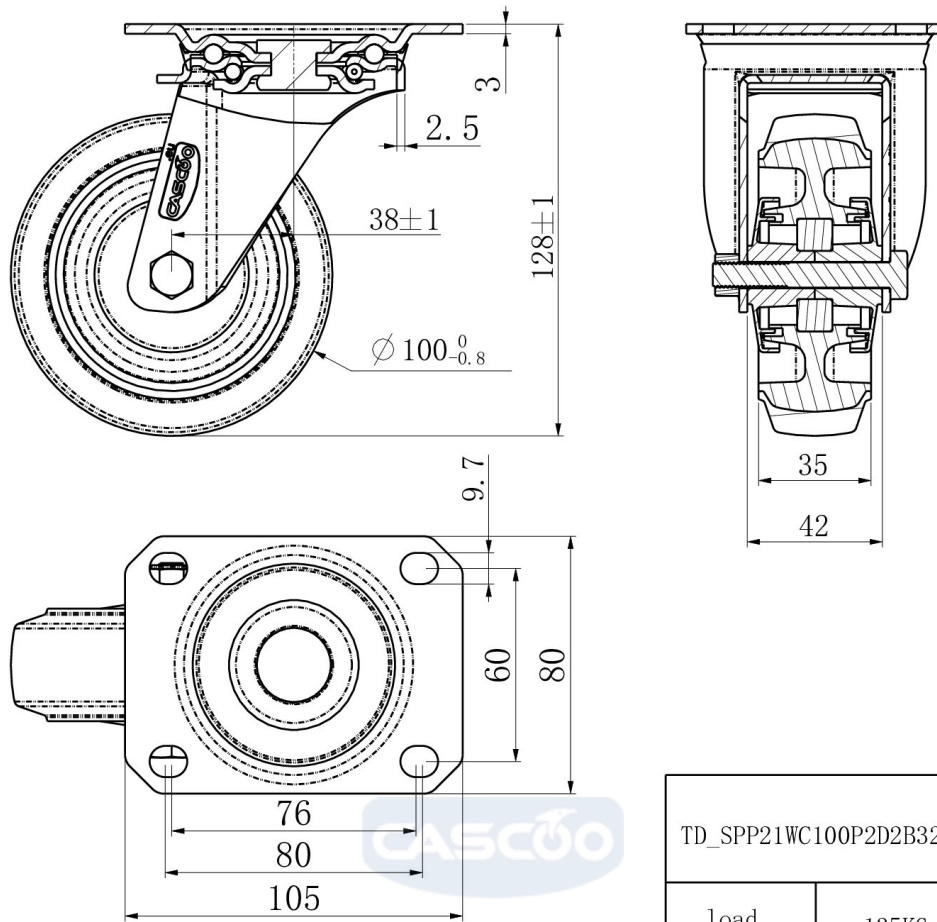

TD_SPP21WC100P2D2B32		
load capacity	135KG	