

CASTOR SBP26WC080P2V2R1W



Product SKU	SBP26WC080P2V2R1W
Standard Compliance	DIN EN 12532
Series	P2V2
Fastening	Plate fastening
Brake and Direction	swivel without brake
Material of the Wheel	polypropylene (PP) wheel center
Tread	thermoplastic rubber tread
Temperature range	-20°C to +60°C
Wheel Diameter	80mm
Load Capacity	80kg
Total Height	105mm
Width of Tread	32mm
wheel hub Width	40mm
Offset	40mm
Dimension of Plate	105x80mm
Hole Spacing of the Plate	80/77x60mm
Wheel Bolt Size	M8
Bushing Diameter	12mm
Weight	0.53kg
Wheel Bearing	roller bearing
Rubber Shore	85° Shore A



CASTOR SBP26WC080P2V2R1W

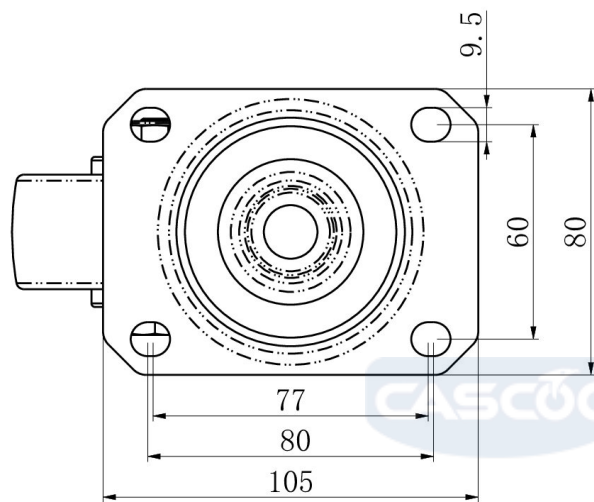
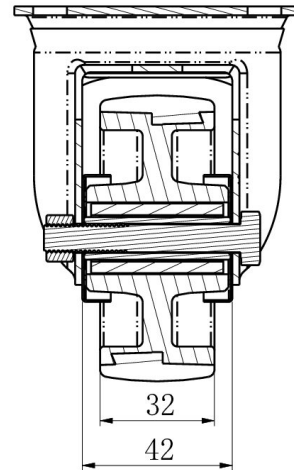
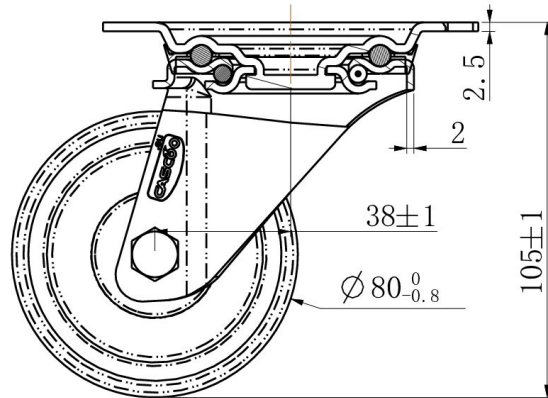

TD_SBP26WC080P2V2R1W		
load capacity	80KG	