

CASTOR HBH85WC125P2V2B32



Product SKU	HBH85WC125P2V2B32
Standard Compliance	DIN EN 12532
Series	P2V2
Fastening	Bolt fastening
Brake and Direction	swivel without brake
Material of the Wheel	polypropylene (PP) wheel center
Tread	thermoplastic rubber tread
Temperature range	-20°C to +60°C
Wheel Diameter	125mm
Load Capacity	135kg
Total Height	154mm
Width of Tread	32mm
wheel hub Width	50mm
Offset	40mm
Fastening Bolt Hole Diameter	13mm
Wheel Bolt Size	M10
Bushing Diameter	10mm
Weight	0.68kg
Wheel Bearing	ball bearing
Rubber Shore	85° Shore A



CASTOR HBH85WC125P2V2B32

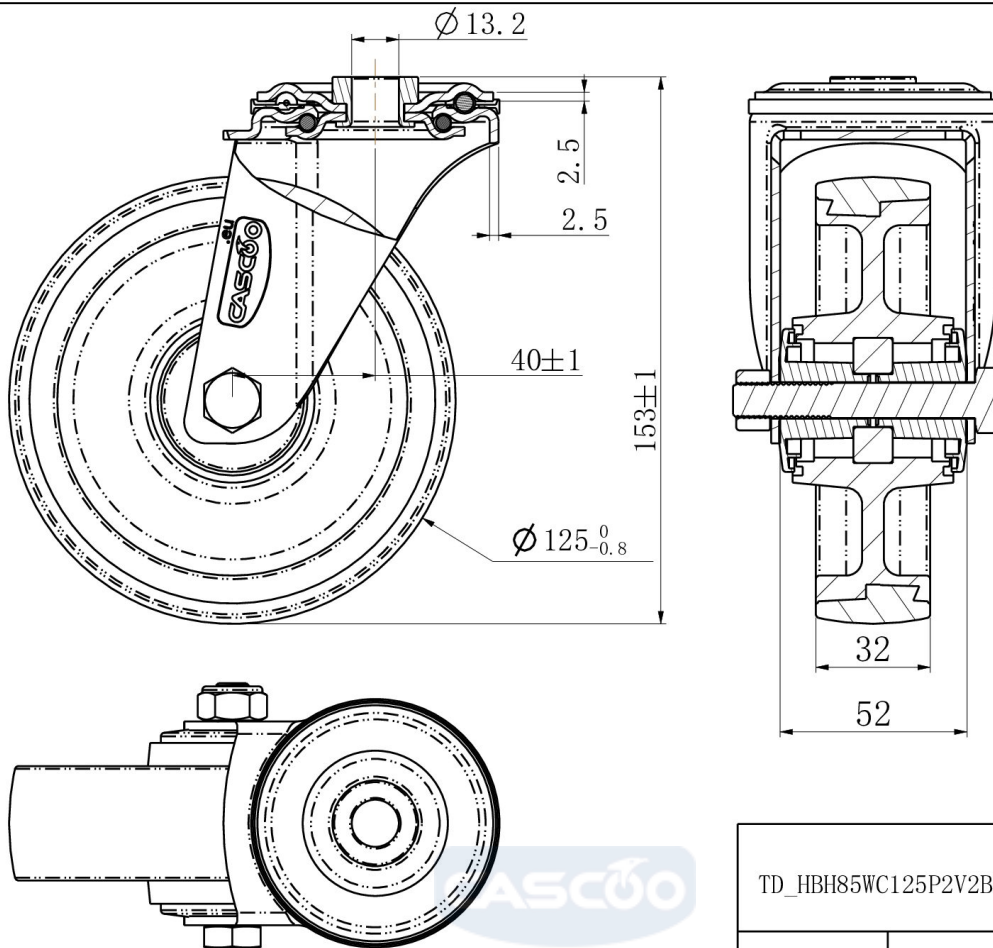

TD_HBH85WC125P2V2B32		
load capacity	135KG	