

CASTOR HBH36WC080P2V2R1W

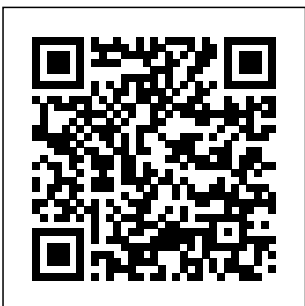

Product SKU	HBH36WC080P2V2R1W
Standard Compliance	DIN EN 12532
Series	P2V2
Fastening	Bolt fastening
Material of the Wheel	polypropylene (PP) wheel center
Tread	thermoplastic rubber tread
Temperature range	-20°C to +60°C
Wheel Diameter	80mm
Load Capacity	80kg
Total Height	104mm
Width of Tread	32mm
wheel hub Width	40mm
Offset	40mm
Fastening Bolt Hole Diameter	13mm
Wheel Bolt Size	M8
Bushing Diameter	12mm
Weight	0.46kg
Wheel Bearing	roller bearing
Rubber Shore	85° Shore A

CASTOR HBH36WC080P2V2R1W

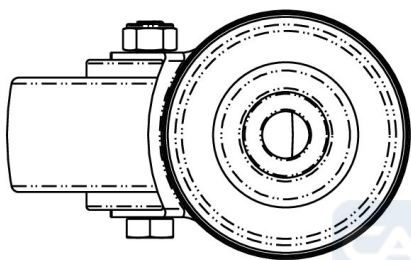
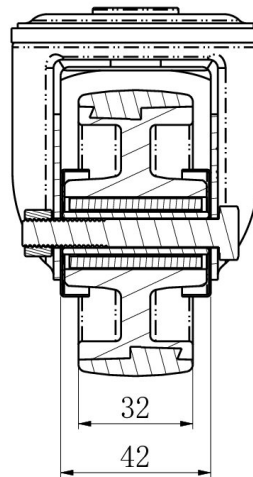
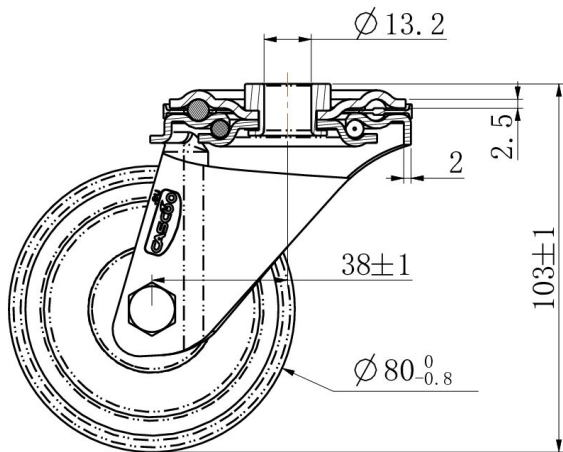

TD_HBH36WC080P2V2R1W

load
capacity

80KG

