

CASTOR HAX15C0080P2T2B42

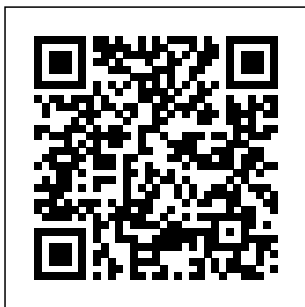

Product SKU	HAX15C0080P2T2B42
Standard Compliance	DIN EN 12530
Series	P2T2
Fastening	Bolt fastening
Brake and Direction	swivel without brake
Material of the Wheel	polypropylene (PP) wheel center
Tread	thermoplastic rubber tread
Temperature range	-20°C to +60°C
Wheel Diameter	80mm
Load Capacity	80kg
Total Height	111mm
Width of Tread	32mm
wheel hub Width	36mm
Offset	37mm
Fastening Bolt Hole Diameter	11mm
Wheel Bolt Size	M8
Bushing Diameter	8mm
Wheel Bearing	ball bearing
Rubber Shore	95° Shore A



CASTOR HAX15C0080P2T2B42

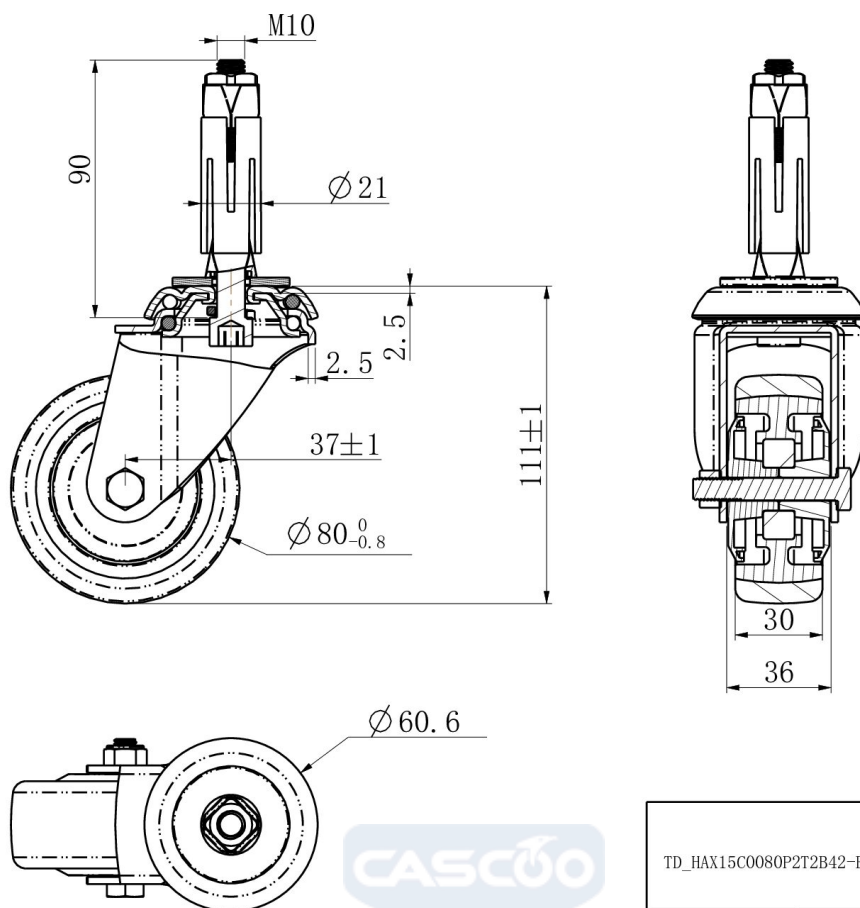

TD_HAX15C0080P2T2B42-EXR02124		
load capacity	80KG	