

CASTOR BPH98WC200N2U6R1W



Product SKU	BPH98WC200N2U6R1W
Standard Compliance	DIN EN 12532
Series	N2U6
Fastening	Bolt fastening
Brake and Direction	back brake
Material of the Wheel	polyamide (PA) wheel center
Tread	polyurethane (PU) tread
Temperature range	-40°C to +80°C
Wheel Diameter	200mm
Load Capacity	250kg
Total Hight	228mm
Width of Tread	48mm
wheel hub Width	59mm
Offset	55mm
Fastening Bolt Hole Diameter	13mm
Swivel Radius	165mm
Wheel Bolt Size	M12
Bushing Diameter	20mm
Weight	2.26kg
Wheel Bearing	roller bearing
Rubber Shore	95° Shore A



CASTOR BPH98WC200N2U6R1W

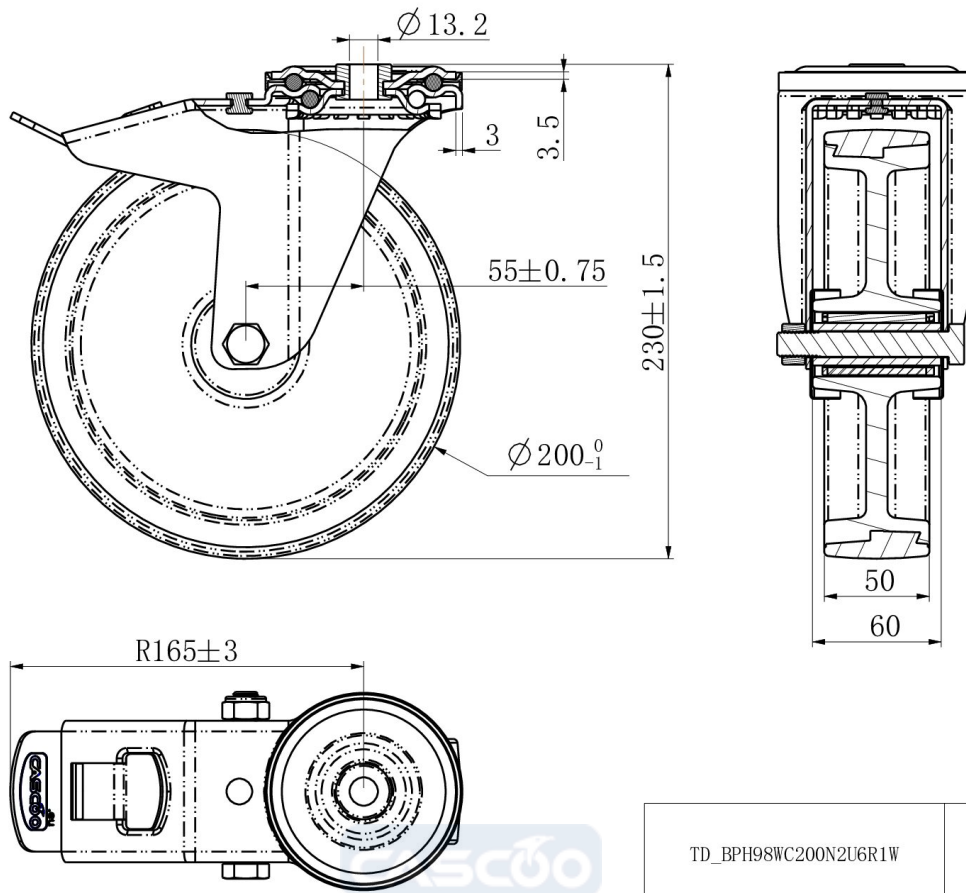

TD_BPH98WC200N2U6R1W		
load capacity	250KG	