

CASTOR BPH98WC160N2U6B32

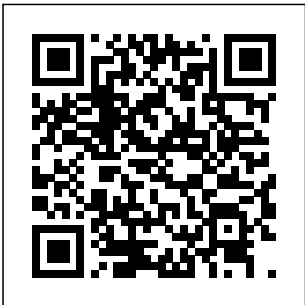

Product SKU	BPH98WC160N2U6B32
Standard Compliance	DIN EN 12532
Series	N2U6
Fastening	Bolt fastening
Brake and Direction	back brake
Material of the Wheel	polyamide (PA) wheel center
Tread	polyurethane (PU) tread
Temperature range	-40°C to +80°C
Wheel Diameter	160mm
Load Capacity	250kg
Total Hight	189mm
Width of Tread	40mm
wheel hub Width	59mm
Offset	55mm
Fastening Bolt Hole Diameter	13mm
Swivel Radius	165mm
Wheel Bolt Size	M12
Bushing Diameter	12mm
Weight	1.89kg
Wheel Bearing	ball bearing
Rubber Shore	95° Shore A



CASTOR BPH98WC160N2U6B32

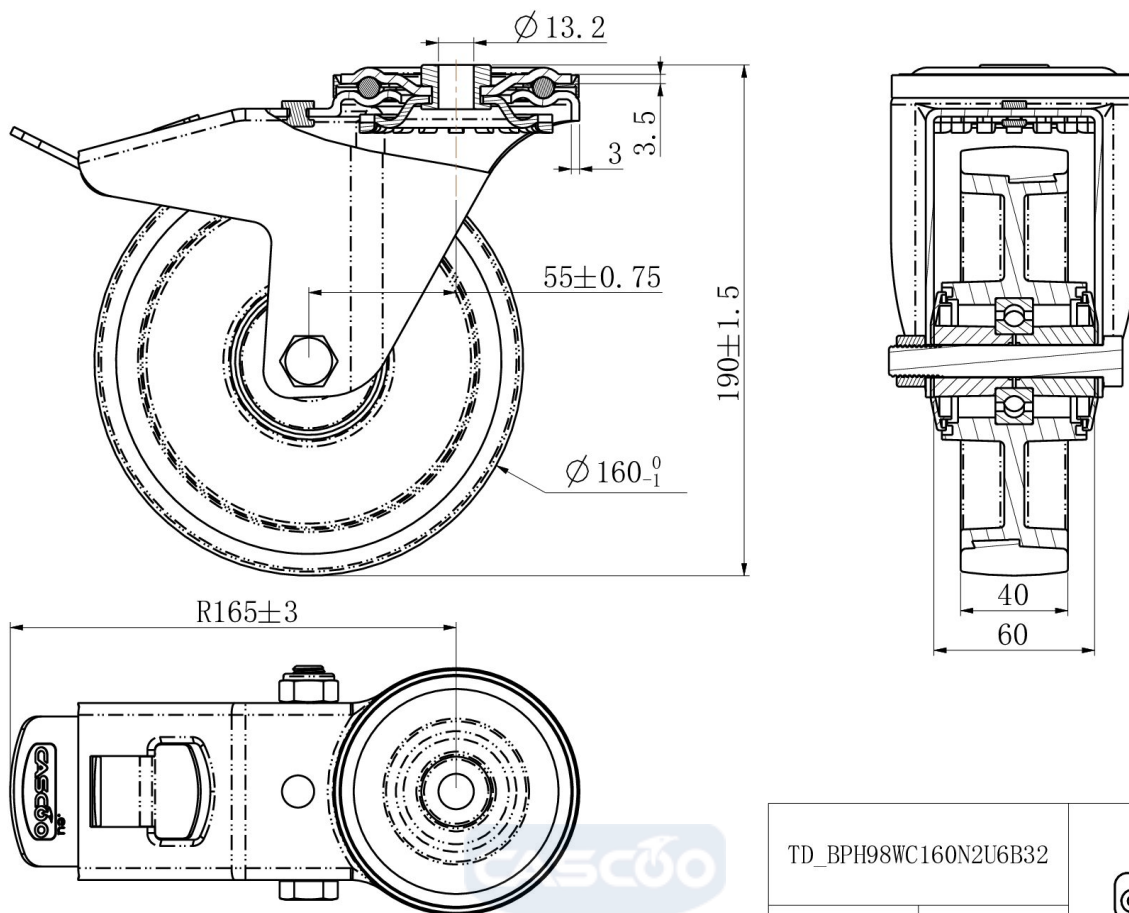

TD_BPH98WC160N2U6B32		
load capacity	250KG	