

CASTOR BPH35WC100N2U6B32



Product SKU	BPH35WC100N2U6B32
Standard Compliance	DIN EN 12532
Series	N2U6
Fastening	Bolt fastening
Brake and Direction	back brake
Material of the Wheel	polyamide (PA) wheel center
Tread	polyurethane (PU) tread
Temperature range	-40°C to +80°C
Wheel Diameter	100mm
Load Capacity	150kg
Total Hight	127mm
Width of Tread	32mm
wheel hub Width	40mm
Offset	40mm
Fastening Bolt Hole Diameter	13mm
Swivel Radius	127mm
Wheel Bolt Size	M8
Bushing Diameter	8mm
Weight	0.76kg
Wheel Bearing	ball bearing
Rubber Shore	95° Shore A



CASTOR BPH35WC100N2U6B32

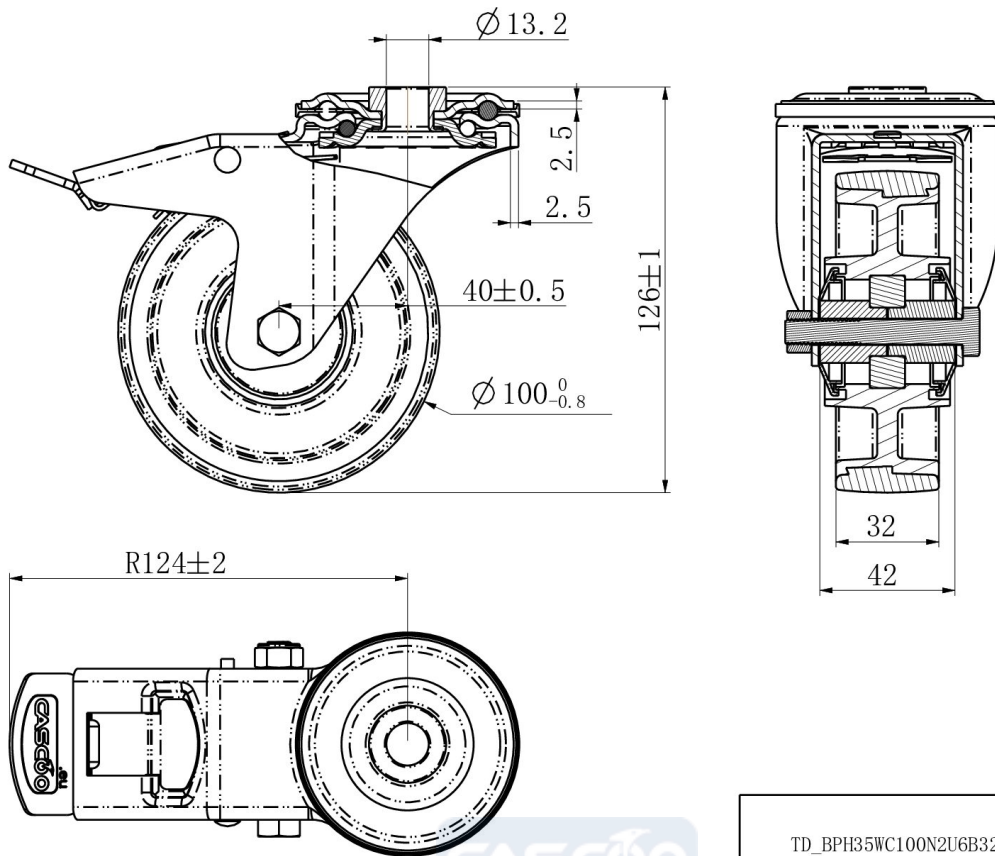

TD_BPH35WC100N2U6B32		
load capacity	150KG	