

CASTOR BPH35WC080R4E1B34



Product SKU	BPH35WC080R4E1B34
Standard Compliance	DIN EN 12532
Series	R4E1
Fastening	Bolt fastening
Brake and Direction	back brake
Material of the Wheel	polyamide (PA) wheel center
Tread	elastic tread
Temperature range	-20°C to +80°C
Wheel Diameter	80mm
Load Capacity	130kg
Total Height	104mm
Width of Tread	35mm
wheel hub Width	40mm
Offset	40mm
Fastening Bolt Hole Diameter	13mm
Swivel Radius	127mm
Wheel Bolt Size	M8
Bushing Diameter	8mm
Weight	0.96kg
Wheel Bearing	ball bearing
Rubber Shore	65° Shore A



CASTOR BPH35WC080R4E1B34

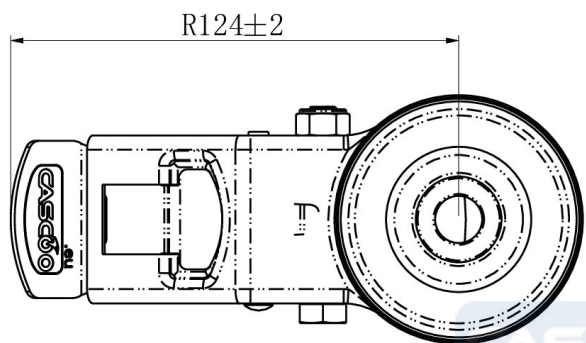
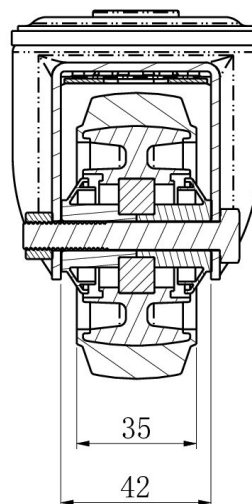
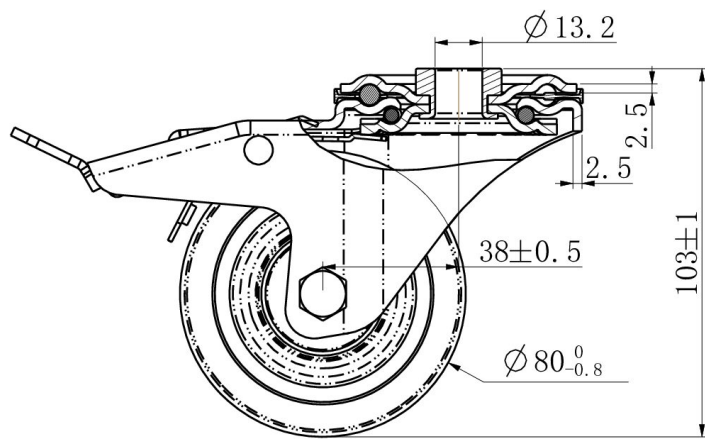

TD_BPH35WC080R4E1B34		
load capacity	130KG	