

CASTOR BBH85WC125N0N0R1W



Product SKU	BBH85WC125N0N0R1W
Standard Compliance	DIN EN 12532
Series	N0N0
Fastening	Bolt fastening
Brake and Direction	back brake
Material of the Wheel	polyamide (PA) wheel center
Tread	polyamide (PA) tread
Temperature range	-40°C to +80°C
Wheel Diameter	125mm
Load Capacity	200kg
Total Height	154mm
Width of Tread	38mm
wheel hub Width	50mm
Offset	45mm
Fastening Bolt Hole Diameter	13mm
Swivel Radius	127mm
Wheel Bolt Size	M10
Bushing Diameter	15mm
Weight	0.94kg
Wheel Bearing	roller bearing



CASTOR BBH85WC125N0N0R1W

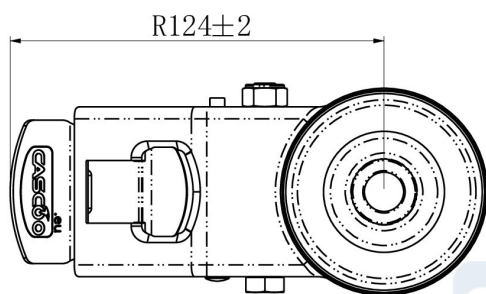
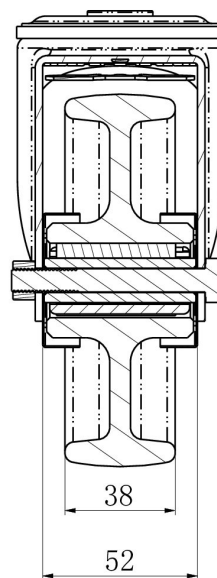
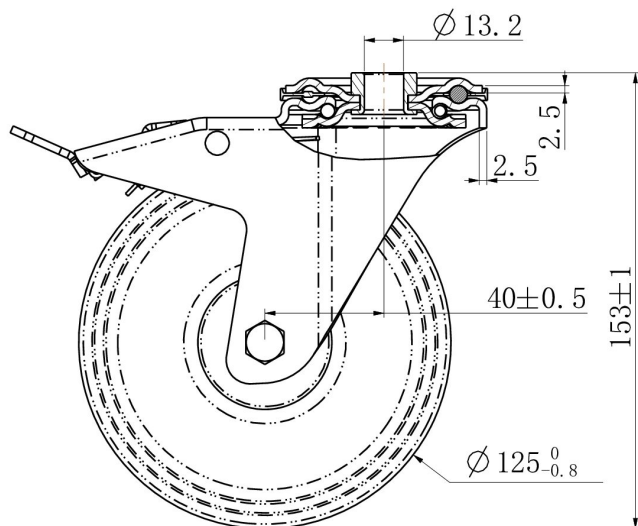

TD_BBH85WC125N0N0R1W		
load capacity	150KG	