

CASTOR BBH35WC080N2U6R1W



| | |
|-------------------------------------|-----------------------------|
| Product SKU | BBH35WC080N2U6R1W |
| Standard Compliance | DIN EN 12532 |
| Series | N2U6 |
| Fastening | Bolt fastening |
| Brake and Direction | back brake |
| Material of the Wheel | polyamide (PA) wheel center |
| Tread | polyurethane (PU) tread |
| Temperature range | -40°C to +80°C |
| Wheel Diameter | 80mm |
| Load Capacity | 130kg |
| Total Hight | 104mm |
| Width of Tread | 32mm |
| wheel hub Width | 40mm |
| Offset | 40mm |
| Fastening Bolt Hole Diameter | 13mm |
| Swivel Radius | 127mm |
| Wheel Bolt Size | M8 |
| Bushing Diameter | 12mm |
| Weight | 0.69kg |
| Wheel Bearing | roller bearing |
| Rubber Shore | 95° Shore A |



CASTOR BBH35WC080N2U6R1W

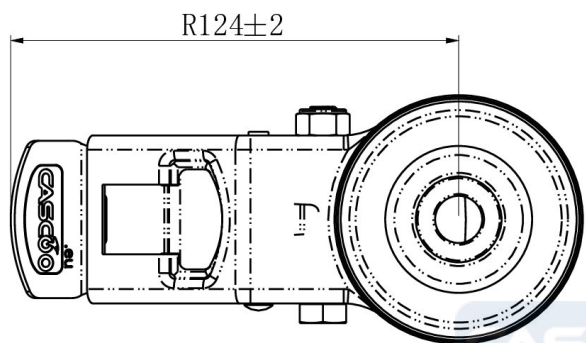
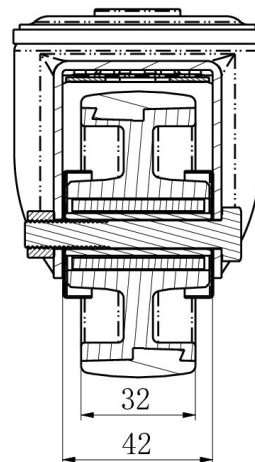
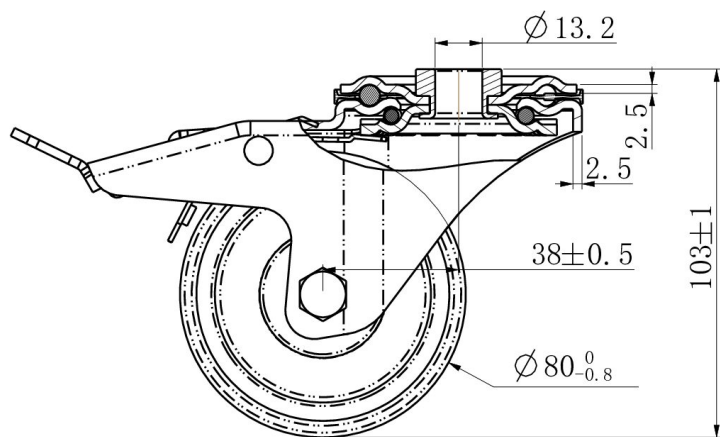

| | | |
|----------------------|-------|--|
| TD_BBH35WC080N2U6R1W | | |
| load capacity | 130KG | |