

CASTOR BAX15C0150P2T2B42



Product SKU	BAX15C0150P2T2B42
Standard Compliance	DIN EN 12530
Series	P2T2
Fastening	Bolt fastening
Brake and Direction	back brake
Material of the Wheel	polypropylene (PP) wheel center
Tread	thermoplastic rubber tread
Temperature range	-20°C to +60°C
Wheel Diameter	150mm
Load Capacity	100kg
Total Height	185mm
Width of Tread	32mm
wheel hub Width	36mm
Offset	40mm
Fastening Bolt Hole Diameter	11mm
Swivel Radius	132mm
Wheel Bolt Size	M8
Bushing Diameter	8mm
Wheel Bearing	ball bearing
Rubber Shore	95° Shore A



CASTOR BAX15C0150P2T2B42

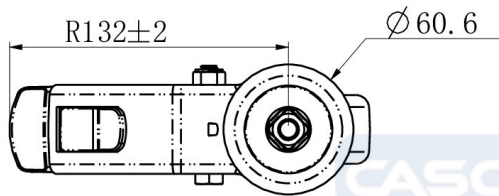
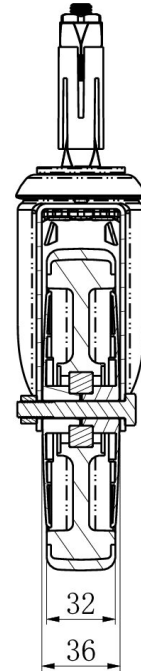
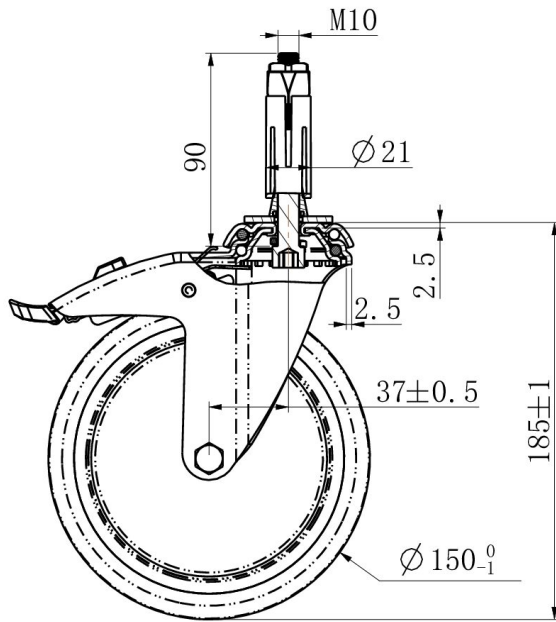

TD_BAX15C0150P2T2B42-EXR02124		
load capacity	100KG	