

CASTOR BAX15C0100P2T2P0N



Product SKU	BAX15C0100P2T2P0N
Standard Compliance	DIN EN 12530
Series	P2T2
Fastening	Bolt fastening
Brake and Direction	back brake
Material of the Wheel	polypropylene (PP) wheel center
Tread	thermoplastic rubber tread
Temperature range	-20°C to +60°C
Wheel Diameter	100mm
Load Capacity	100kg
Total Height	135mm
Width of Tread	32mm
wheel hub Width	36mm
Offset	37mm
Fastening Bolt Hole Diameter	11mm
Swivel Radius	132mm
Wheel Bolt Size	M8
Bushing Diameter	12mm
Wheel Bearing	plain bearing
Rubber Shore	95° Shore A



CASTOR BAX15C0100P2T2P0N

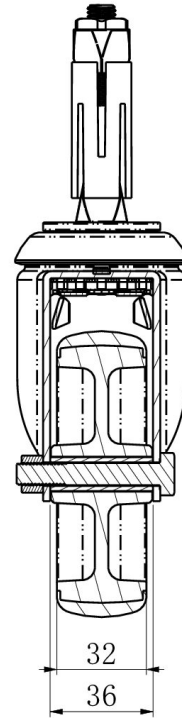
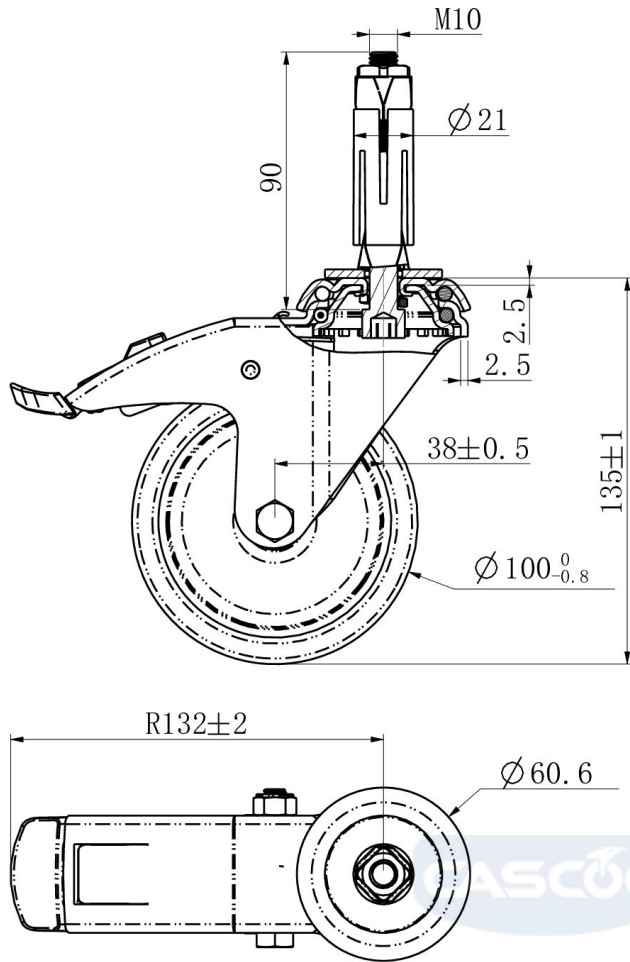

TD_BAX15C0100P2T2P0N-EXR02124

load capacity

100KG

