

IRTOPYÖRÄ 200R4F1R0N



Tuotteen SKU	200R4F1R0N
Standardinmukaisuus	DIN EN 12532
Sarja	R4F1
Pyörän materiaali	polyamidi
Kulutuspinta	elastinen kumi
Lämpötila-alue	-20°C to +80°C
Pyörän halkaisija	200mm
Kantavuus	350kg
Kulutuspinnan leveys	46mm
Pyörän navan leveys	59mm
Pyörän pultin koko	M12
Holkin halkaisija	20mm
Paino	1.21kg
Pyörän laakeri	neulalaakeri
Shore-kovuus	75° Shore A



IRTOPYÖRÄ 200R4F1R0N

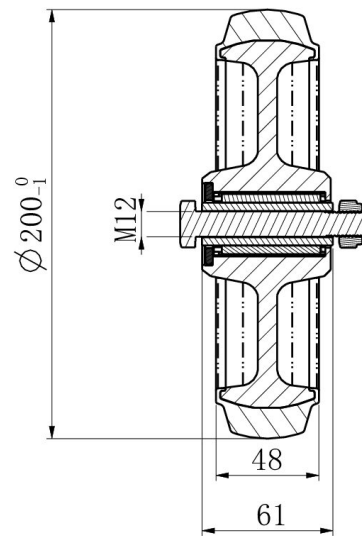
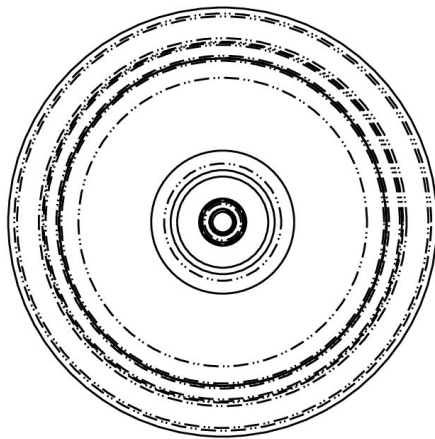

TD_200R4F1R0N

load
capacity

350KG

