

IRTOPYÖRÄ 200P2V2R1W



Tuotteen SKU	200P2V2R1W
Standardinmukaisuus	DIN EN 12532
Sarja	P2V2
Pyörän materiaali	polypropeeni
Kulutuspinta	termoplastinen kumi
Lämpötila-alue	-20°C to +60°C
Pyörän halkaisija	200mm
Kantavuus	200kg
Kulutuspinnan leveys	48mm
Pyörän navan leveys	59mm
Pyörän pultin koko	M12
Holkin halkaisija	20mm
Paino	0.93kg
Pyörän laakeri	neulalaakeri
Shore-kovuus	85° Shore A





IRTOPYÖRÄ 200P2V2R1W

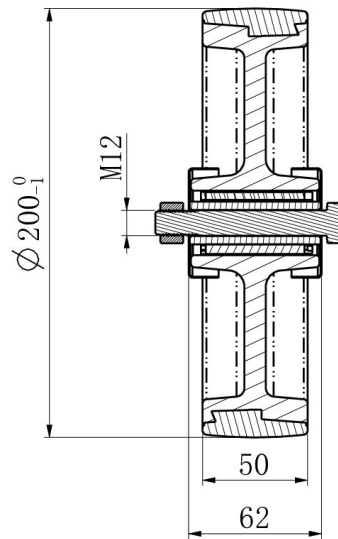
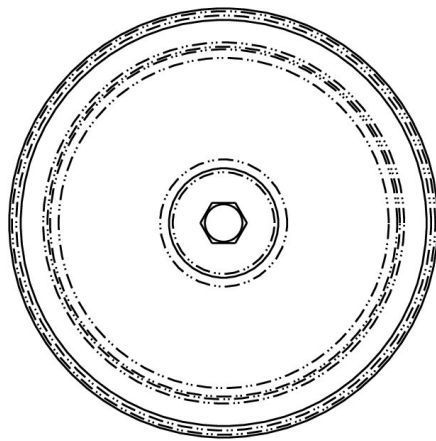

TD_200P2V2R1W		
load capacity	200KG	