



IRTOPYÖRÄ 200P2G2B32



Tuotteen SKU	200P2G2B32
Standardinmukaisuus	DIN EN 12532
Sarja	P2G2
Pyörän materiaali	polypropeeni
Kulutuspinta	termoplastinen kumi
Lämpötila-alue	-20°C to +60°C
Pyörän halkaisija	200mm
Kantavuus	250kg
Kulutuspinnan leveys	40mm
Pyörän navan leveys	59mm
Pyörän pultin koko	M12
Holkin halkaisija	12mm
Paino	0.75kg
Pyörän laakeri	kuulalaakeri
Shore-kovuus	70° Shore A



IRTOPYÖRÄ 200P2G2B32

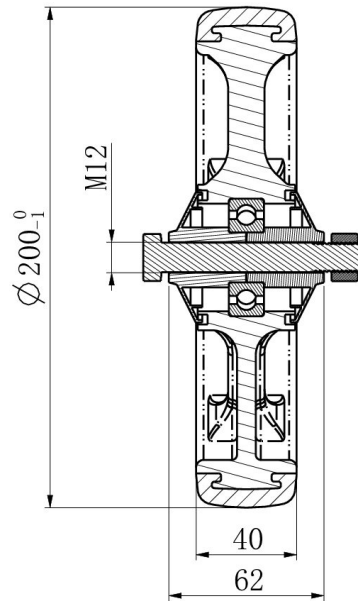
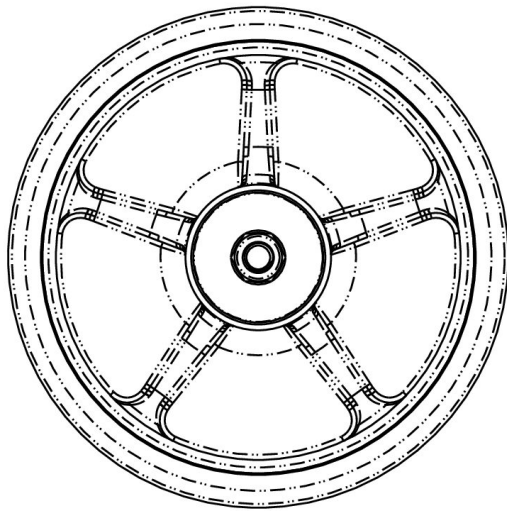

TD_200P2G2B32

load
capacity

250KG

