

IRTOPYÖRÄ 125T6P2R1W



Tuotteen SKU	125T6P2R1W
Standardinmukaisuus	DIN EN 12532
Sarja	T6P2
Pyörän materiaali	polypropeeni
Kulutuspinta	polypropeeni
Lämpötila-alue	-20°C to +60°C
Pyörän halkaisija	125mm
Kantavuus	200kg
Kulutuspinnan leveys	36mm
Pyörän navan leveys	50mm
Pyörän pultin koko	M10
Holkin halkaisija	15mm
Paino	0.48kg
Pyörän laakeri	neulalaakeri





IRTOPYÖRÄ 125T6P2R1W

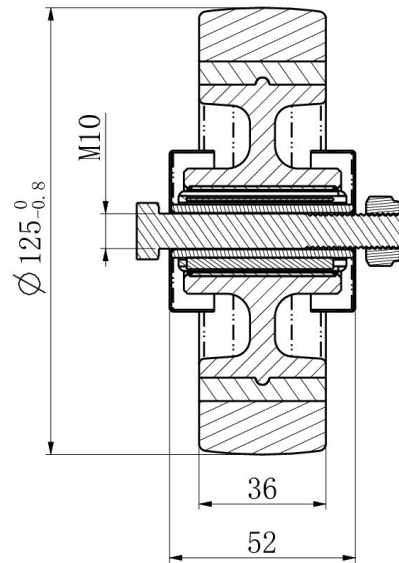
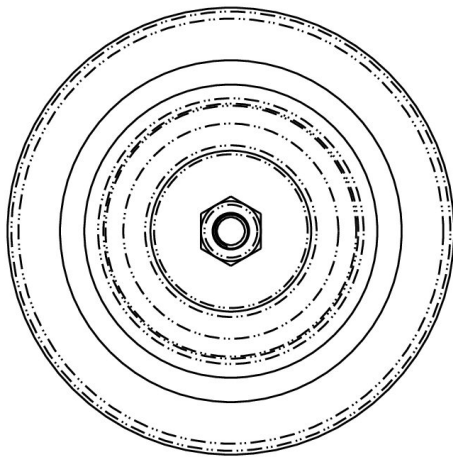

TD_125T6P2R1W		
load capacity	200KG	