

IRTOPYÖRÄ 125M6N2B32

Tuotteen SKU	125M6N2B32
Standardinmukaisuus	DIN EN 12532
Sarja	M6N2
Pyörän materiaali	polyamidi
Kulutuspinta	polyamidi
Lämpötila-alue	-20°C to +80°C
Pyörän halkaisija	125mm
Kantavuus	200kg
Kulutuspinnan leveys	36mm
Pyörän navan leveys	50mm
Pyörän pultin koko	M10
Holkin halkaisija	10mm
Pyörän laakeri	kuulalaakeri





IRTOPYÖRÄ 125M6N2B32

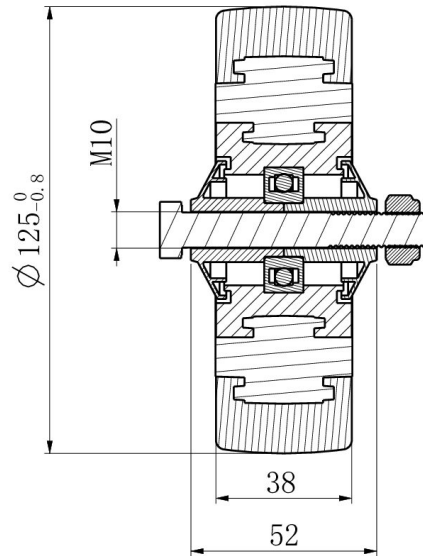
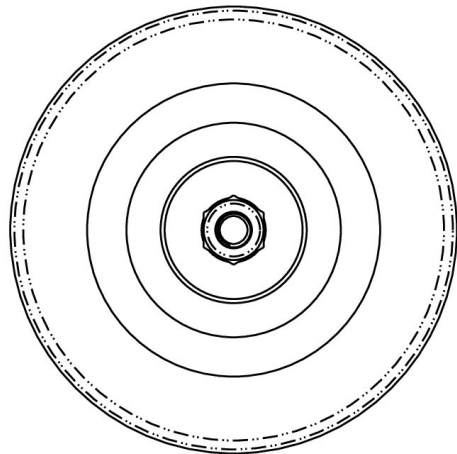

TD_125M6N2B32		
load capacity	200KG	