



## IRTOPYÖRÄ 080R4E1B34



<b>Tuotteen SKU</b>	080R4E1B34
<b>Standardinmukaisuus</b>	DIN EN 12532
<b>Sarja</b>	R4E1
<b>Pyörän materiaali</b>	polyamidi
<b>Kulutuspinta</b>	elastinen kumi
<b>Lämpötila-alue</b>	-20°C to +80°C
<b>Pyörän halkaisija</b>	80mm
<b>Kantavuus</b>	150kg
<b>Kulutuspinnan leveys</b>	35mm
<b>Pyörän navan leveys</b>	40mm
<b>Pyörän pultin koko</b>	M8
<b>Holkin halkaisija</b>	8mm
<b>Paino</b>	0.16kg
<b>Pyörän laakeri</b>	kuulalaakeri
<b>Shore-kovuus</b>	65° Shore A





# IRTOPYÖRÄ 080R4E1B34

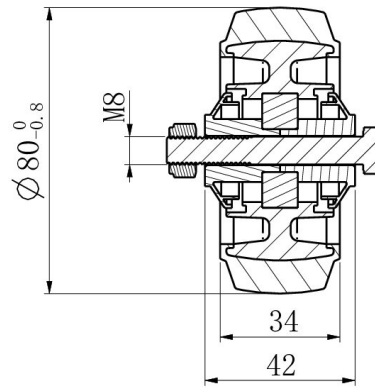

TD_080R4E1B34		
load capacity	150KG	