

## RATTAKOMPLEKT HPH35WC100M6N2B32



<b>Toote SKU</b>	HPH35WC100M6N2B32
<b>Standardivastavus</b>	DIN EN 12532
<b>Seeria</b>	M6N2
<b>Kinnitamine</b>	Poltkinnitusega
<b>Pidur ja suund</b>	pöörlev ilma pidurita
<b>Ratta materjal</b>	ratta keskosa polüamiid (PA)
<b>Protektor</b>	turvis polüamiid (PA)
<b>Temperatuurivahemik</b>	-20°C kuni +80°C
<b>Ratta läbimõõt</b>	100mm
<b>Kandevõime</b>	160kg
<b>Kogukõrgus</b>	127mm
<b>Protektori laius</b>	36mm
<b>Ratta naba laius</b>	40mm
<b>Nihe</b>	40mm
<b>Kinnituspoldi ava läbimõõt</b>	13mm
<b>Rattapoldi suurus</b>	M8
<b>Puksi läbimõõt</b>	8mm
<b>Rattalaager</b>	kuullaager



# RATTAKOMPLEKT HPH35WC100M6N2B32

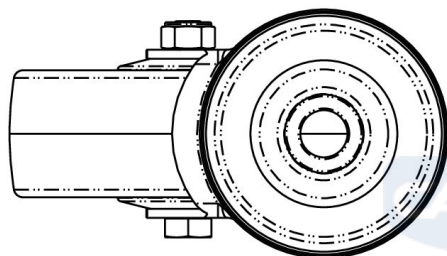
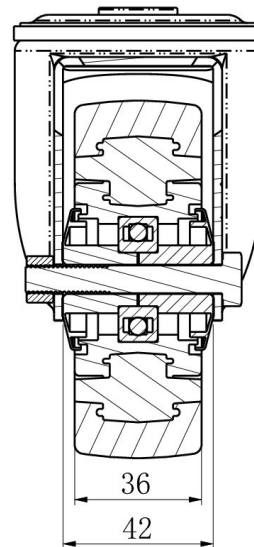
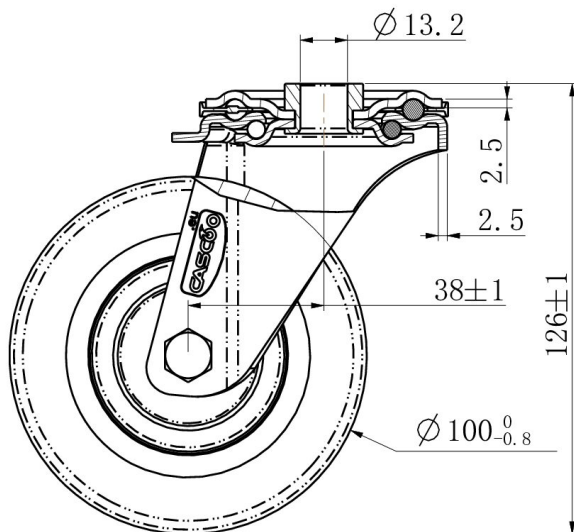

TD\_HPH35WC100M6N2B32

load capacity

150KG

