

RATTAKOMPLEKT DIRSPP21WC100P2D2B32



Toote SKU	DIRSPP21WC100P2D2B32
Standardivastavus	DIN EN 12532
Seeria	P2D2
Kinnitamine	Plaatkinnitusega
Pidur ja suund	suunalukuga
Ratta materjal	ratta keskosa polüpropüleen (PP)
Protektor	turvis termoplastiline kumm
Temperatuurivahemik	-20°C kuni +60°C
Ratta läbimõõt	100mm
Kandevõime	135kg
Kogukõrgus	128mm
Protektori laius	35mm
Ratta naba laius	42mm
Nihe	38mm
Plaadi mõõtmed	105x80mm
Plaadi aukaugus	80/77x60mm
Rattapoldi suurus	M8
Puksi läbimõõt	8mm
Kaal	0.7kg
Rattalaager	kuullaager
Kummi kõvadus	70° Shore A



RATTAKOMPLEKT DIRSPP21WC100P2D2B32

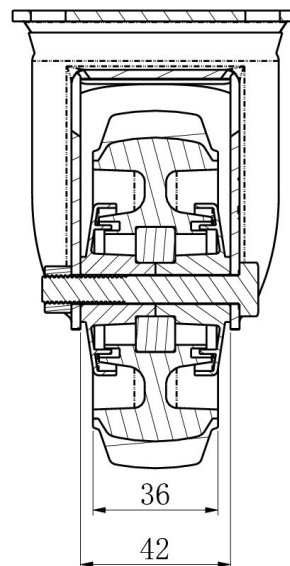
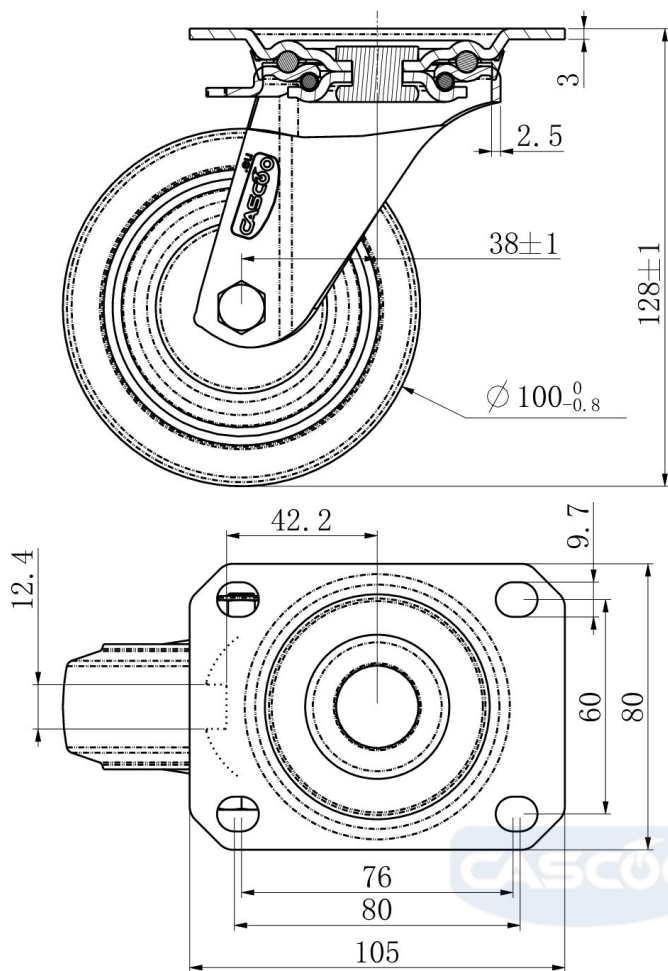

TD_DIRSPP21WC100P2D2B32		
load capacity	135KG	