

## RATTAKOMPLEKT BPH35WC100T6P2R1W

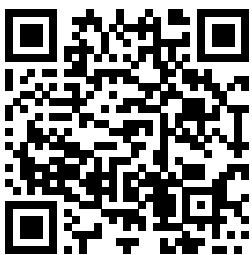

<b>Toote SKU</b>	BPH35WC100T6P2R1W
<b>Standardivastavus</b>	DIN EN 12532
<b>Seeria</b>	T6P2
<b>Kinnitamine</b>	Poltkinnitusega
<b>Pidur ja suund</b>	tagapiduriga
<b>Ratta materjal</b>	ratta keskosa polüpropüleen (PP)
<b>Protektor</b>	turvis polüpropüleen (PP)
<b>Temperatuurivahemik</b>	-20°C kuni +60°C
<b>Ratta läbimõõt</b>	100mm
<b>Kandevõime</b>	160kg
<b>Kogukõrgus</b>	127mm
<b>Protektori laius</b>	36mm
<b>Ratta naba laius</b>	40mm
<b>Nihe</b>	40mm
<b>Kinnituspoldi ava läbimõõt</b>	13mm
<b>Pöörderaadius</b>	127mm
<b>Rattapoldi suurus</b>	M8
<b>Puksi läbimõõt</b>	12mm
<b>Kaal</b>	0.8kg
<b>Rattalaager</b>	nõellaager



# RATTAKOMPLEKT BPH35WC100T6P2R1W

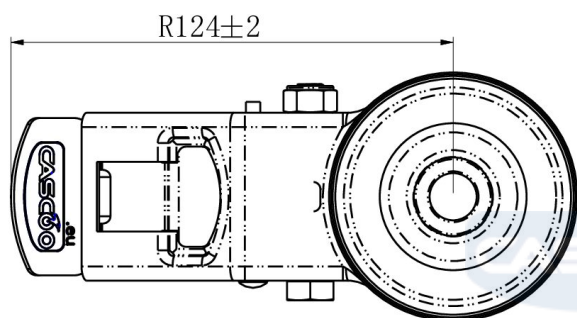
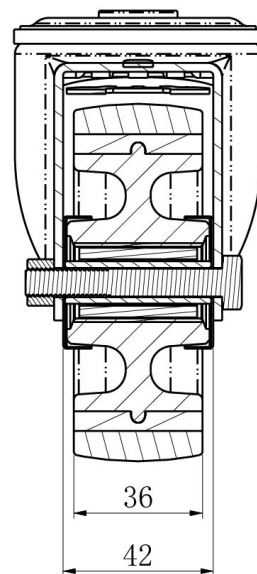
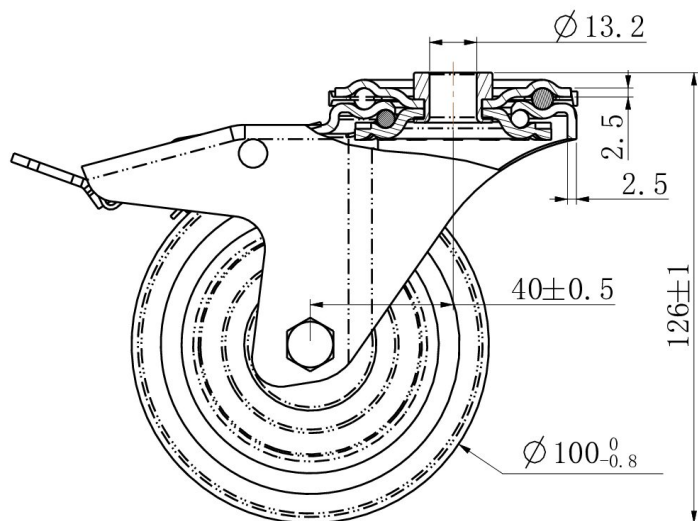

TD\_BPH35WC100T6P2R1W

load  
capacity

150KG

