

RATAS 200R4F1R0N

Toote SKU	200R4F1R0N
Standardivastavus	DIN EN 12532
Seeria	R4F1
Ratta materjal	ratta keskosa polüamiid (PA)
Protektor	turvis elastne kumm (elastic)
Temperatuurivahemik	-20°C kuni +80°C
Ratta läbimõõt	200mm
Kandevõime	350kg
Protektori laius	46mm
Ratta naba laius	59mm
Rattapoldi suurus	M12
Puksi läbimõõt	20mm
Kaal	1.21kg
Rattalaager	nõellaager
Kummi kõvadus	75° Shore A

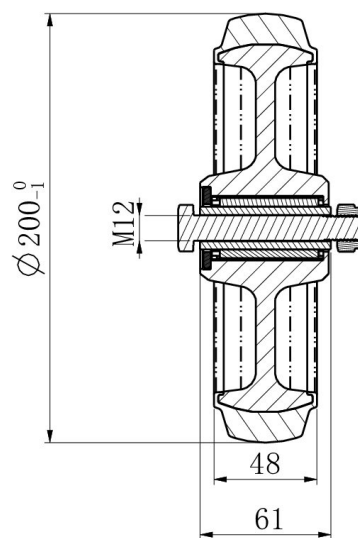

RATAS 200R4F1R0N

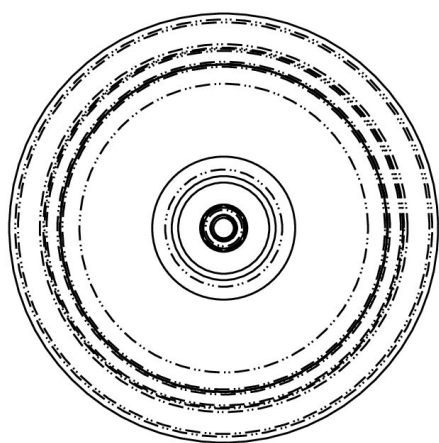

TD_200R4F1R0N

load
capacity

350KG

