

RATAS 200P2V2R1W



Toote SKU	200P2V2R1W
Standardivastavus	DIN EN 12532
Seeria	P2V2
Ratta materjal	ratta keskosa polüpropüleen (PP)
Protektor	turvis termoplastiline kumm
Temperatuurivahemik	-20°C kuni +60°C
Ratta läbimõõt	200mm
Kandevõime	200kg
Protektori laius	48mm
Ratta naba laius	59mm
Rattapoldi suurus	M12
Puksi läbimõõt	20mm
Kaal	0.93kg
Rattalaager	nõellaager
Kummi kõvadus	85° Shore A



RATAS 200P2V2R1W

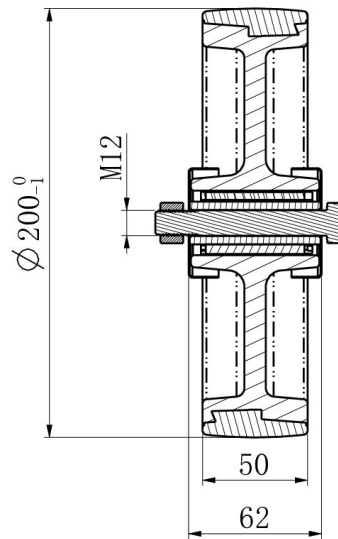
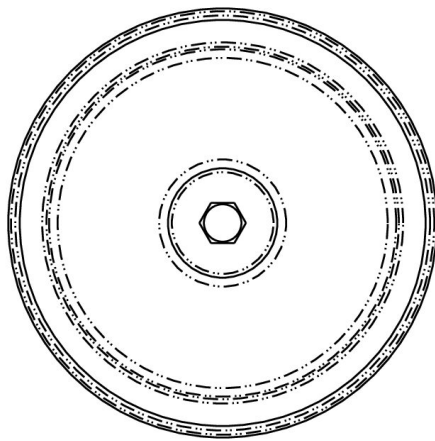

TD_200P2V2R1W		
load capacity	200KG	