

RATAS 160R4E2D34



Toote SKU	160R4E2D34
Standardivastavus	DIN EN 12532
Seeria	R4E2
Ratta materjal	ratta keskosa polüamiid (PA)
Protektor	turvis elastne kumm (elastic)
Temperatuurivahemik	-20°C kuni +80°C
Ratta läbimõõt	160mm
Kandevõime	300kg
Protektori laius	46mm
Ratta naba laius	59mm
Rattapoldi suurus	M12
Puksi läbimõõt	12mm
Kaal	0.86kg
Rattalaager	topelt kuullaager
Kummi kõvadus	65° Shore A



RATAS 160R4E2D34

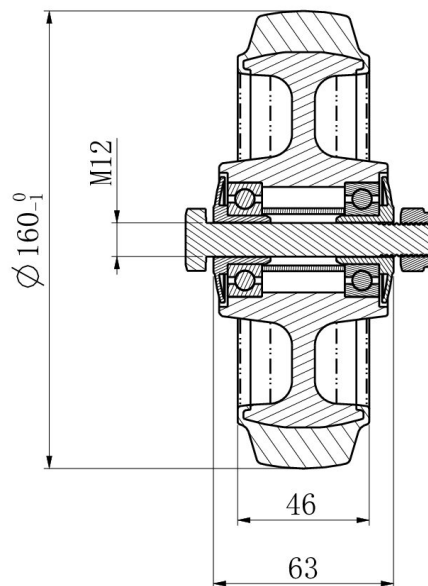
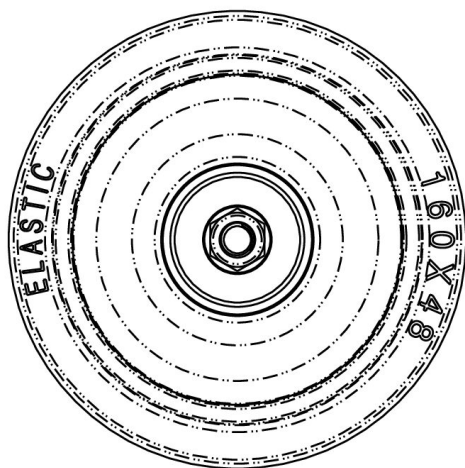

TD_160R4E2D34		
load capacity	300KG	