

RATAS 160N2U6B32



Toote SKU	160N2U6B32
Standardivastavus	DIN EN 12532
Seeria	N2U6
Ratta materjal	ratta keskosa polüamiid (PA)
Protektor	turvis polüuretaan (PU)
Temperatuurivahemik	-40°C kuni +80°C
Ratta läbimõõt	160mm
Kandevõime	350kg
Protektori laius	40mm
Ratta naba laius	59mm
Rattapoldi suurus	M12
Puksi läbimõõt	12mm
Kaal	0.72kg
Rattalaager	kuullaager
Kummi kõvadus	95° Shore A



RATAS 160N2U6B32

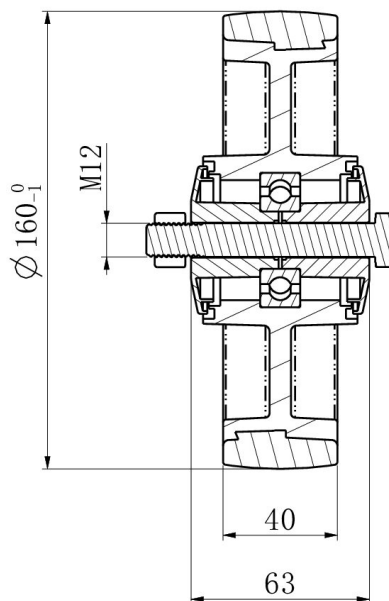
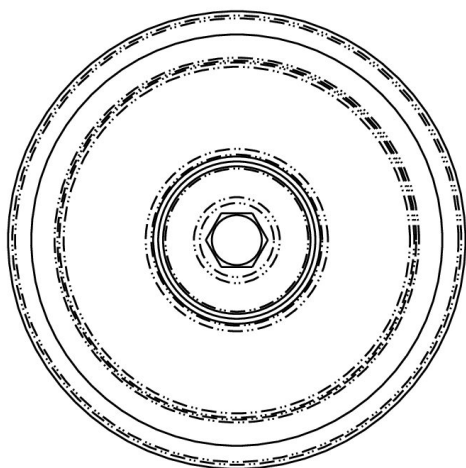

TD_160N2U6B32	
load capacity	300KG

