

RATAS 125R4F1R0N



Toote SKU	125R4F1R0N
Standardivastavus	DIN EN 12532
Seeria	R4F1
Ratta materjal	ratta keskosa polüamiid (PA)
Protektor	turvis elastne kumm (elastic)
Temperatuurivahemik	-20°C kuni +80°C
Ratta läbimõõt	125mm
Kandevõime	200kg
Protektori laius	38mm
Ratta naba laius	50mm
Rattapoldi suurus	M10
Puksi läbimõõt	15mm
Kaal	0.45kg
Rattalaager	nõellaager
Kummi kõvadus	75° Shore A



RATAS 125R4F1R0N

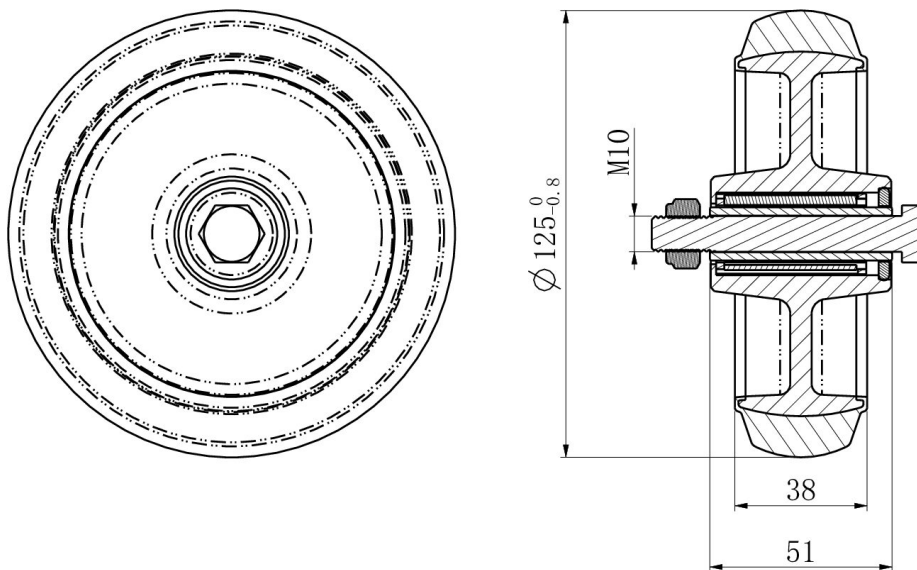

TD_125R4F1R0N		
load capacity	200KG	