

RATAS 125R4E2B34



Toote SKU	125R4E2B34
Standardivastavus	DIN EN 12532
Seeria	R4E2
Ratta materjal	ratta keskosa polüamiid (PA)
Protektor	turvis elastne kumm (elastic)
Temperatuurivahemik	-20°C kuni +80°C
Ratta läbimõõt	125mm
Kandevõime	250kg
Protektori laius	38mm
Ratta naba laius	50mm
Rattapoldi suurus	M10
Puksi läbimõõt	10mm
Kaal	0.41kg
Rattalaager	kuullaager
Kummi kõvadus	65° Shore A



RATAS 125R4E2B34

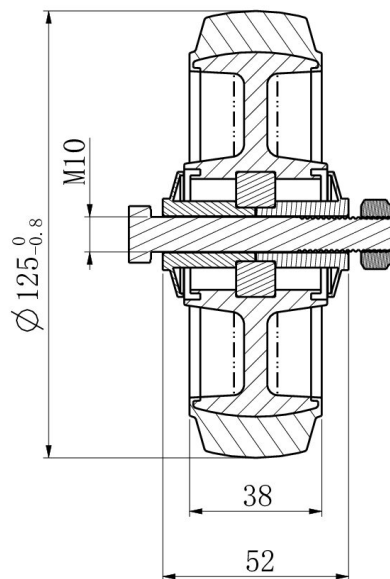
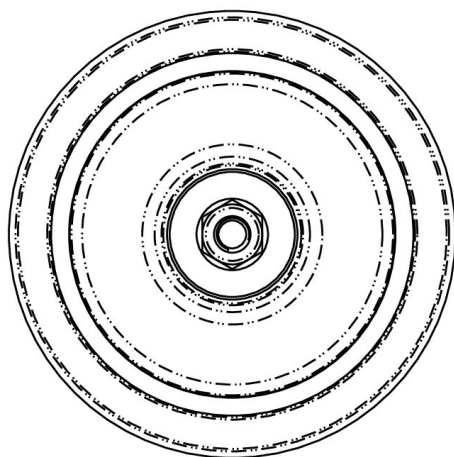

TD_125R4E2B34		
load capacity	220KG	