

RATAS 125P2G2B32E



Toote SKU	125P2G2B32E
Standardivastavus	DIN EN 12532
Seeria	P2G2 (ESD)
Ratta materjal	ratta keskosa polüpropüleen (PP)
Protektor	turvis termoplastiline kumm
Temperatuurivahemik	-20°C kuni +60°C
Ratta läbimõõt	125mm
Kandevõime	120kg
Protektori laius	35mm
Ratta naba laius	50mm
Rattapoldi suurus	M10
Puksi läbimõõt	10mm
Kaal	0.34kg
Rattalaager	kuullaager
Special Features	elektrostaatiline (ESD)



RATAS 125P2G2B32E

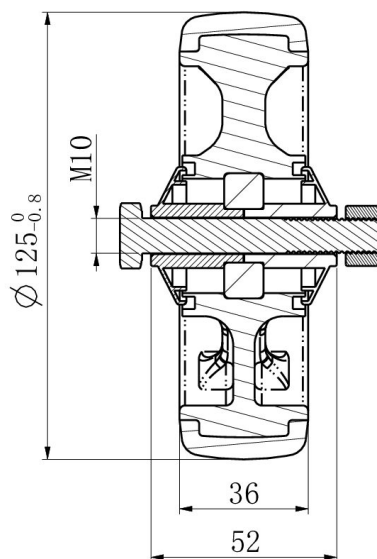
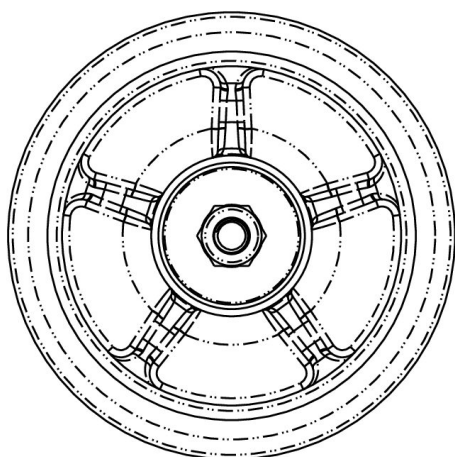

TD_125P2G2B32E		
load capacity	120KG	